

SafeNet PCIe HSM 6.3

Installation Guide

Document Information

Product Version	6.3
Document Part Number	007-011329-012
Release Date	14 July 2017

Revision History

Revision	Date	Reason
A	14 July 2017	Initial release.

Trademarks, Copyrights, and Third-Party Software

Copyright 2001-2017 Gemalto. All rights reserved. Gemalto and the Gemalto logo are trademarks and service marks of Gemalto and/or its subsidiaries and are registered in certain countries. All other trademarks and service marks, whether registered or not in specific countries, are the property of their respective owners.

Acknowledgements

This product includes software developed by the OpenSSL Project for use in the OpenSSL Toolkit.
(<http://www.openssl.org>)

This product includes cryptographic software written by Eric Young (ey@cryptsoft.com). This product includes software written by Tim Hudson (tjh@cryptsoft.com).

This product includes software developed by the University of California, Berkeley and its contributors.

This product uses Brian Gladman's AES implementation.

Refer to the End User License Agreement for more information.

Disclaimer

All information herein is either public information or is the property of and owned solely by Gemalto and/or its subsidiaries who shall have and keep the sole right to file patent applications or any other kind of intellectual property protection in connection with such information.

Nothing herein shall be construed as implying or granting to you any rights, by license, grant or otherwise, under any intellectual and/or industrial property rights of or concerning any of Gemalto's information.

This document can be used for informational, non-commercial, internal, and personal use only provided that:

- The copyright notice, the confidentiality and proprietary legend and this full warning notice appear in all copies.
- This document shall not be posted on any publicly accessible network computer or broadcast in any media, and no modification of any part of this document shall be made.

Use for any other purpose is expressly prohibited and may result in severe civil and criminal liabilities.

The information contained in this document is provided "AS IS" without any warranty of any kind. Unless otherwise expressly agreed in writing, Gemalto makes no warranty as to the value or accuracy of information contained herein.

The document could include technical inaccuracies or typographical errors. Changes are periodically added to the information herein. Furthermore, Gemalto reserves the right to make any change or improvement in the specifications data, information, and the like described herein, at any time.

Gemalto hereby disclaims all warranties and conditions with regard to the information contained herein, including all implied warranties of merchantability, fitness for a particular purpose, title and non-infringement. In no event shall Gemalto be liable, whether in contract, tort or otherwise, for any indirect, special or consequential damages or any damages whatsoever including but not limited to damages resulting from loss of use, data, profits, revenues, or customers, arising out of or in connection with the use or performance of information contained in this document.

Gemalto does not and shall not warrant that this product will be resistant to all possible attacks and shall not incur, and disclaims, any liability in this respect. Even if each product is compliant with current security standards in force on the date of their design, security mechanisms' resistance necessarily evolves according to the state of the art in security and notably under the emergence of new attacks. Under no circumstances, shall Gemalto be held liable for any third party actions and in particular in case of any successful attack against systems or equipment incorporating Gemalto products. Gemalto disclaims any liability with respect to security for direct, indirect, incidental or consequential damages that result from any use of its products. It is further stressed that independent testing and verification by the person using the product is particularly encouraged, especially in any application in which defective, incorrect or insecure functioning could result in damage to persons or property, denial of service, or loss of privacy.

Regulatory Compliance

This product complies with the following regulatory regulations. To ensure compliancy, ensure that you install the products as specified in the installation instructions and use only Gemalto-supplied or approved accessories.

USA, FCC

This device complies with Part 15 of the FCC rules. Operation is subject to the following two conditions:

- (1) This device may not cause harmful interference, and
- (2) This device must accept any interference received, including interference that may cause undesired operation.

This equipment has been tested and found to comply with the limits for a "Class B" digital device, pursuant to part 15 of the FCC rules. These limits are designed to provide reasonable protection against harmful interference in a residential installation. This equipment generates, uses and can radiate radio frequency energy and, if not installed and used in accordance with the instructions, may cause harmful interference to radio communications. However, there is no guarantee that interference will not occur in a particular installation.

If this equipment does cause harmful interference to radio or television reception, which can be determined by turning the equipment off and on, the user is encouraged to try to correct the interference by one or more of the following measures:

- Reorient or relocate the receiving antenna
- Increase the separation between the equipment and receiver
- Connect the equipment into an outlet on a circuit different from that to which the receiver is connected
- Consult the dealer or an experienced radio/TV technician for help
- Changes or modifications not expressly approved by Gemalto could void the user's authority to operate the equipment.

Canada

This class B digital apparatus meets all requirements of the Canadian interference- causing equipment regulations.

Europe

This product is in conformity with the protection requirements of EC Council Directive 2004/108/EC. Conformity is declared to the following applicable standards for electro-magnetic compatibility immunity and susceptibility; CISPR22 and IEC801. This product satisfies the CLASS B limits of EN 55022.

CONTENTS

PREFACE	About the Installation Guide	8
Customer Release Notes		8
Gemalto Rebranding		8
Audience		9
Document Conventions		9
Notes		9
Cautions		10
Warnings		10
Command Syntax and Typeface Conventions		10
Support Contacts		11
1	SafeNet Network HSM Hardware Installation	12
SafeNet Network HSM Required Items		13
SafeNet PED?		15
Additional Options?		17
Installing the SafeNet Network HSM Hardware		19
Installation Notes		19
Installing the SafeNet Network HSM Hardware		19
2	SafeNet PCIe HSM Hardware Installation	23
Will SafeNet PCIe HSM work with host computer/server XYZ ?		23
SafeNet PCIe HSM Required Items		24
Password-Authenticated SafeNet PCIe HSM		24
PED-Authenticated SafeNet PCIe HSM		25
Backup Device		28
Installing the SafeNet PCIe HSM Hardware		29
Installing the SafeNet PCIe HSM Card Into the Host Computer		29
Connecting a Local PED		31
Connecting a Remote PED		32
3	SafeNet USB HSM Hardware Installation	33
SafeNet USB HSM Required Items		34
Password-Authenticated SafeNet USB HSM		34
PED-Authenticated SafeNet USB HSM		35
Installing the Battery in the SafeNet USB HSM or Backup HSM		39
Installing the SafeNet USB HSM Hardware		41
4	SafeNet Remote PED Installation and Configuration	46
Installing and Configuring a SafeNet Remote PED		47
Required Items		47
Remote PED Setup		49

5	SafeNet HSM Client Software Installation	56
AIX	SafeNet HSM Client Installation	57
	Prerequisites	57
	Installing the Client Software	58
	Uninstalling the SafeNet Client Software	60
	Java Component Installation	60
	Removing Components	61
	Interrupting the Installation	61
	After Installation	62
HP-UX	SafeNet HSM Client Installation	63
	Prerequisites	63
	Installing the SafeNet HSM Client Software	64
	Uninstalling the SafeNet HSM Client Software	66
	Java Component Installation	66
	Removing Components	67
	Interrupting the Installation	67
	After Installation	68
Linux	SafeNet HSM Client Installation	69
	Prerequisites	69
	Installing the Client Software	70
	Uninstalling the SafeNet HSM Client Software	73
	Java	73
	Removing Components	74
	[Ctrl] [C] - If you interrupt the installation	74
	Scripted or Unattended Installation	75
	SUSE Linux on IBM PPC	76
	32-bit Client on 64-bit RedHat 6	76
	After Installation	78
Solaris	SafeNet HSM Client Installation	79
	Prerequisites	79
	Installing the Client Software	80
	Uninstalling the SafeNet Luna HSM Client Software	81
	Java	82
	Removing Components	83
	[Ctrl] [C] - If you interrupt the installation	83
	After Installation	83
Windows	SafeNet HSM Client Installation	84
	Required Client Software	84
	Windows Server Prerequisites	84
	Installing the SafeNet HSM Client Software	84
	Scripted or unattended installation of the SafeNet Client	88
	Java	89
	CSP and KSP	90
	Using 32-bit Applications With the SafeNet Client	91
	Uninstalling, Modifying, or Repairing the SafeNet Client Software	93
	After Installation	93
	Troubleshooting	93
	Administrator privileges	96
Windows Server 2012	SafeNet HSM Client Supplemental Configuration	97

Scripted / Unattended Installation on Windows	101
Installing the SafeNet Client For All SafeNet Products	101
Installing the SafeNet Client For SafeNet Network HSM	101
Installing the Luna Client for SafeNet PCIe HSM	102
Installing the Luna Client For SafeNet USB HSM	102
Installing the Luna Client for SafeNet Remote Backup HSM	103
Installing the Luna Client for Remote PED	103

PREFACE

About the Installation Guide

This document describes how to install the SafeNet HSM hardware and the SafeNet Client software. Refer to the following chapters to install the hardware and software components applicable to you:

SafeNet HSM hardware installation

- ["SafeNet Network HSM Hardware Installation" on page 12](#)
- ["SafeNet PCIe HSM Hardware Installation" on page 23](#)
- ["SafeNet USB HSM Hardware Installation" on page 33](#)

SafeNet Remote PED installation and configuration

- ["SafeNet Remote PED Installation and Configuration" on page 46](#)

SafeNet Client software installation

- ["SafeNet HSM Client Software Installation " on page 56](#)

Document information

This preface also includes the following information about this document:

- ["Customer Release Notes" below](#)
- ["Gemalto Rebranding" below](#)
- ["Audience" on the next page](#)
- ["Document Conventions" on the next page](#)
- ["Support Contacts" on page 11](#)

For information regarding the document status and revision history, see ["Document Information" on page 2](#)

Customer Release Notes

The customer release notes (CRN) provide important information about this release that is not included in the customer documentation. It is strongly recommended that you read the CRN to fully understand the capabilities, limitations, and known issues for this release. You can view or download the latest version of the CRN for this release at the following location:

- http://www.securedbysafenet.com/releasenotes/luna/crn_luna_hsm_6-3.pdf

Gemalto Rebranding

In early 2015, Gemalto completed its acquisition of SafeNet, Inc. As part of the process of rationalizing the product portfolios between the two organizations, the Luna name has been removed from the SafeNet HSM product line, with the SafeNet name being retained. As a result, the product names for SafeNet HSMs have changed as follows:

Old product name	New product name
Luna SA HSM	SafeNet Network HSM
Luna PCI-E HSM	SafeNet PCIe HSM
Luna G5 HSM	SafeNet USB HSM
Luna PED	SafeNet PED
Luna Client	SafeNet HSM Client
Luna Dock	SafeNet Dock
Luna Backup HSM	SafeNet Backup HSM
Luna CSP	SafeNet CSP
Luna JSP	SafeNet JSP
Luna KSP	SafeNet KSP



Note: These branding changes apply to the documentation only. The SafeNet HSM software and utilities continue to use the old names.

Audience

This document is intended for personnel responsible for maintaining your organization's security infrastructure. This includes SafeNet HSM users and security officers, key manager administrators, and network administrators.

All products manufactured and distributed by Gemalto are designed to be installed, operated, and maintained by personnel who have the knowledge, training, and qualifications required to safely perform the tasks assigned to them. The information, processes, and procedures contained in this document are intended for use by trained and qualified personnel only.

It is assumed that the users of this document are proficient with security concepts.

Document Conventions

This document uses standard conventions for describing the user interface and for alerting you to important information.

Notes

Notes are used to alert you to important or helpful information. They use the following format:



Note: Take note. Contains important or helpful information.

Cautions

Cautions are used to alert you to important information that may help prevent unexpected results or data loss. They use the following format:



CAUTION: Exercise caution. Contains important information that may help prevent unexpected results or data loss.

Warnings

Warnings are used to alert you to the potential for catastrophic data loss or personal injury. They use the following format:



WARNING! Be extremely careful and obey all safety and security measures. In this situation you might do something that could result in catastrophic data loss or personal injury.

Command Syntax and Typeface Conventions

Format	Convention
bold	The bold attribute is used to indicate the following: <ul style="list-style-type: none"> • Command-line commands and options (Type dir /p.) • Button names (Click Save As.) • Check box and radio button names (Select the Print Duplex check box.) • Dialog box titles (On the Protect Document dialog box, click Yes.) • Field names (User Name: Enter the name of the user.) • Menu names (On the File menu, click Save.) (Click Menu > Go To > Folders.) • User input (In the Date box, type April 1.)
<i>italics</i>	In type, the italic attribute is used for emphasis or to indicate a related document. (See the <i>Installation Guide</i> for more information.)
<variable>	In command descriptions, angle brackets represent variables. You must substitute a value for command line arguments that are enclosed in angle brackets.
[optional] [<optional>]	Represent optional keywords or <variables> in a command line description. Optionally enter the keyword or <variable> that is enclosed in square brackets, if it is necessary or desirable to complete the task.
{ a b c } {<a> <c>}	Represent required alternate keywords or <variables> in a command line description. You must choose one command line argument enclosed within the braces. Choices are separated by vertical (OR) bars.
[a b c] [<a> <c>]	Represent optional alternate keywords or variables in a command line description. Choose one command line argument enclosed within the braces, if desired. Choices are separated by vertical (OR) bars.

Support Contacts

Contact method	Contact	
Phone (Subject to change. An up-to-date list is maintained on the Technical Support Customer Portal)	Global	+1 410-931-7520
	Australia	1800.020.183
	India	000.800.100.4290
	Netherlands	0800.022.2996
	New Zealand	0800.440.359
	Portugal	800.863.499
	Singapore	800.1302.029
	Spain	900.938.717
	Sweden	020.791.028
	Switzerland	0800.564.849
	United Kingdom	0800.056.3158
	United States	(800) 545-6608
Web	https://safenet.gemalto.com	
Technical Support Customer Portal	https://supportportal.gemalto.com Existing customers with a Technical Support Customer Portal account can log in to manage incidents, get the latest software upgrades, and access the Knowledge Base. To create a new account, click the Register link at the top of the page. You will need your Customer Identifier number.	



SafeNet Network HSM Hardware Installation

This chapter describes how to install and connect a SafeNet Network HSM. To ensure a successful installation, perform the following tasks in the order indicated:

1. Ensure that you have all of the required components, as listed in ["SafeNet Network HSM Required Items" on the next page](#)
2. Install and connect the hardware, as described in ["Installing the SafeNet Network HSM Hardware" on page 19](#)

SafeNet Network HSM Required Items

Follow this checklist to verify that you have all of items required for the installation.

Qty	Item
1	 <p data-bbox="245 680 634 709">SafeNet Network HSM Appliance</p>
2	 <p data-bbox="245 1224 1336 1253">Power Supply Cord (one for each power supply; style to suit country for which you ordered) (*)</p>
1	 <p data-bbox="245 1719 534 1749">Null-Modem Serial Cable</p>

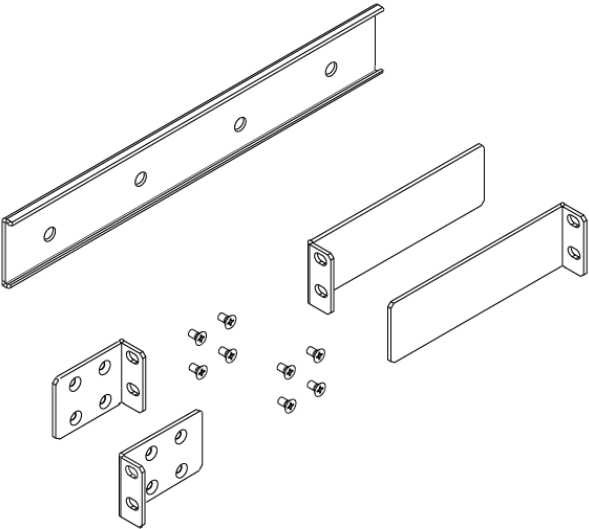
Qty	Item
1	 <p data-bbox="245 520 626 552">USB 2.0 to RS232 Serial Adapter</p>
1	 <p data-bbox="245 1192 1187 1325">Set of: - 2 front Mounting Brackets with Screws, - 2 Side Bracket Guides, and - 2 Sliding Rear Brackets (fit into the guides for rear support adjustable positioning).</p>
1	Client / SDK Software (**)

(* We mention power cords, because you need them, but they are no longer included with the shipment from our factory. Many customers are buying HSMs from one country, but shipping them for final deployment to different countries, which has resulted in many wasted power cords that are incorrect format for destination countries. So, please source your power cords locally for the deployment destination.)

(** Software is available by download from Gemalto. Physical media for software and documentation are special-request items.)

SafeNet PED?

Additionally, if your SafeNet Network HSM is the PED-authenticated version, then you might also have ordered the following items (next page).

Note that you can use SafeNet PEDs and PED Keys that you already own and use with other HSMs, if they have firmware 2.4.0 or later – PEDs of the same type are interchangeable, and PED Keys can be used with multiple HSMs if that is appropriate in your context. You should purchase the number you need for your own convenient operation, and for backup/standby units as your security policies might require.

If you intend to use Remote PED functions, you will need a SafeNet PED 2 Remote version.

The standard SafeNet PED 2 is capable of local operation only.

Your order should include a PED 2 device. To use PED-authenticated SafeNet HSM with Remote PED function requires a Remote Capable PED – the standard PED does not have the Remote capability. They appear almost identical except for a label “PED Remote” on the front, and the availability of the “Remote” menu when powered on.



PED remote

SafeNet Local PED cable

Your order should include a 9-pin, Micro-D to Micro-D cable for local PED operation.



SafeNet Remote PED cable (Remote PED only)

If you ordered a SafeNet remote PED, your order should include a Type A to Mini B USB cable for remote PED operation.



SafeNet Remote PED Power Supply Kit (Remote PED only *)

If you ordered a SafeNet Remote PED, your order should include a SafeNet Remote PED power supply kit. The power supply is auto-sensing and includes replaceable mains plug modules for international use.



[* If you received a refreshed PED (updated internal hardware, and PED firmware 2.8.0 or newer), it is powered via the USB connection and does not require a separate, external power supply; none is supplied.]

PED Keys and Labels

Your order should include a ten-pack of iKey 1000 blank PED Keys and peel-and-stick labels.

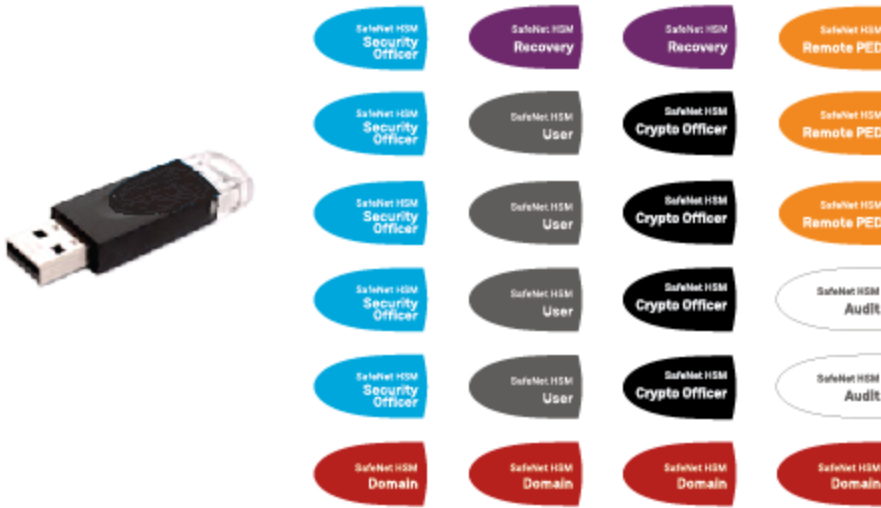

(* Standard PED 2 is shown. To use SafeNet Network HSM with Remote PED function requires a Remote Capable PED – the standard PED does not have the Remote capability. They appear identical except for the availability of the “Remote” menu when powered on.)

Additional Options?

[Optionally]

You can back up your selected SafeNet Network HSM partition contents (root keys, certificates, other items) to a SafeNet Remote Backup HSM.

Qty	Item
1	 <p data-bbox="245 1612 529 1646">SafeNet Backup HSM(*)</p>

(* The SafeNet SafeNet Backup HSM is a backup-storage option, suitable for off-site storage, and for backing up multiple HSM partitions. Its contents are automatically secured at the same level of authentication security (Password versus PED) as the HSM it is backing up. The SafeNet Backup HSM can be connected directly [locally] to an HSM, or it can be connected to a computer to backup remotely located HSMs, in conjunction with Remote PED.)

[Optionally]

You can use your SafeNet Network HSM appliance to expand the functionality and reach of applications that you might previously have conducted with SafeNet PCMCIA tokens (SafeNet PCM and SafeNet PCM CA4), such as Registration Authority for Smart Card issuance, or Key Escrow for managed PKI implementations, or root-key management in the production of encrypted removable storage devices, among other possibilities. This function makes use of the SafeNet USB HSM (very similar in appearance to the Backup HSM).

Qty	Item
1	 <p data-bbox="245 825 574 856">SafeNet USB HSM (for PKI)</p>

The authentication method for external HSMs must match the authentication method for any appliance HSM with which they are used.

Installing the SafeNet Network HSM Hardware

This section provides basic SafeNet Network HSM hardware installation instructions (mounting in a rack, connecting cables, etc.). The SafeNet Network HSM appliance comes with front brackets and side-rails and sliders for the rear brackets, packed separately in the carton.

Installation Notes

1. Any computer that is to act as a client to the SafeNet Network HSM appliance must have the Client software installed. Windows users should log in to your computer as a user with Administrator privileges.
2. A computer that is to be used only for administering the SafeNet Network HSM does not need the Client software – only an SSH client such as the PuTTY program that we have provided for Windows, or the SSH utilities that come standard with most Linux and UNIX platforms.
3. A computer that is to be used for Remote PED workstation operation against a SafeNet Network HSM must have the PEDServer software and PED 2 USB driver installed. Applies to select Windows platforms only.
4. All three tasks (Client, administration, and Remote PED) can be performed on a single computer, but in normal practice they are often separate tasks for separate computers.
5. See the Remote PED section if you will be using Remote PED.

Installing the SafeNet Network HSM Hardware

You can optionally install the brackets if they suit your equipment rack. The front brackets can be installed with their tabs forward (for flush-mount of the appliance) or reversed, to allow the front of the appliance to stand out from the rack. The rear brackets install in either direction – as appropriate for your rack post spacing – with the brackets simply sliding into the rails on each side of the appliance.

The supplied brackets are designed and intended for 4-point support of the appliance, in racks with rear-post depth up to 22 inches.



CAUTION: Do not attempt to mount the appliance using only the front brackets – damage can occur.



Note: The standard SafeNet PED 2 is capable of local operation only.

To install the SafeNet Network HSM hardware

1. Install and adjust rails and brackets to suit your equipment rack.

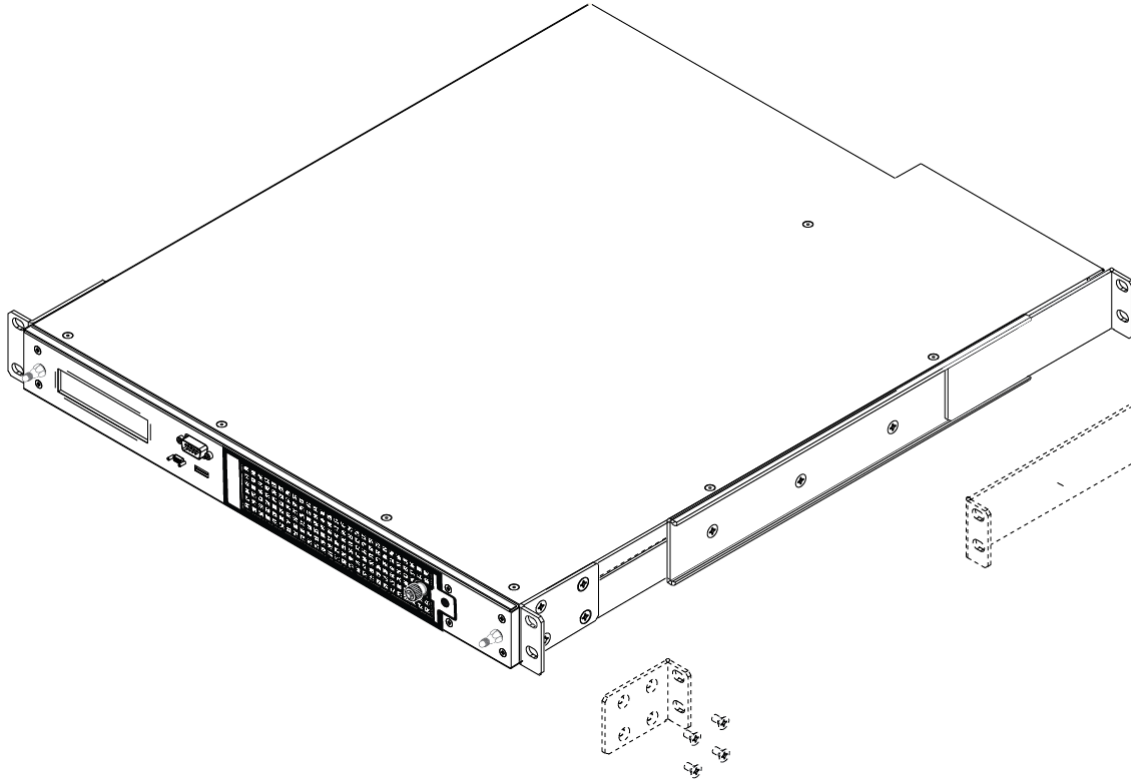

2. Mount the appliance in your equipment rack. Alternatively, ignore the rails and mounting tabs, and rest the SafeNet Network HSM appliance on a mounting tray or shelf suitable for your specific style and brand of equipment rack.



CAUTION: Support the weight of the appliance until all four brackets are secured.

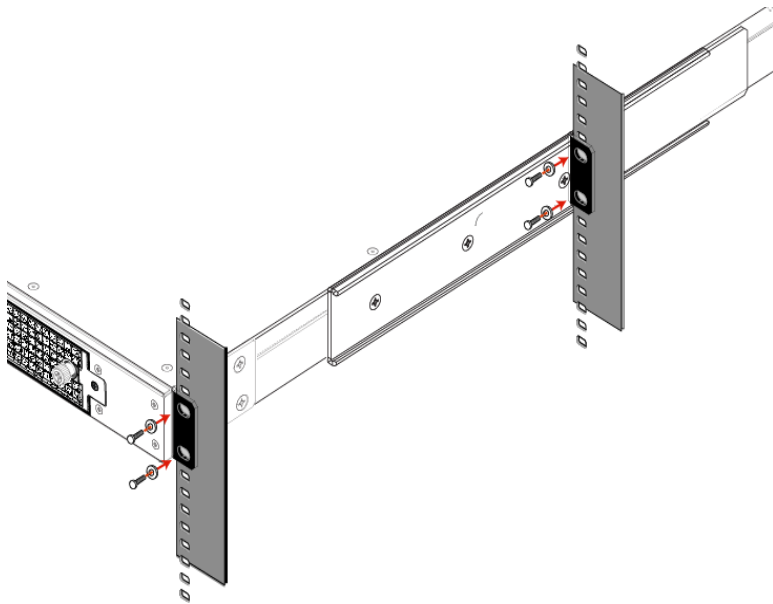

3. Insert the power (a) and network (b) cables at the rear panel.

For proper redundancy and best reliability, the power cables should connect to two completely independent power sources.

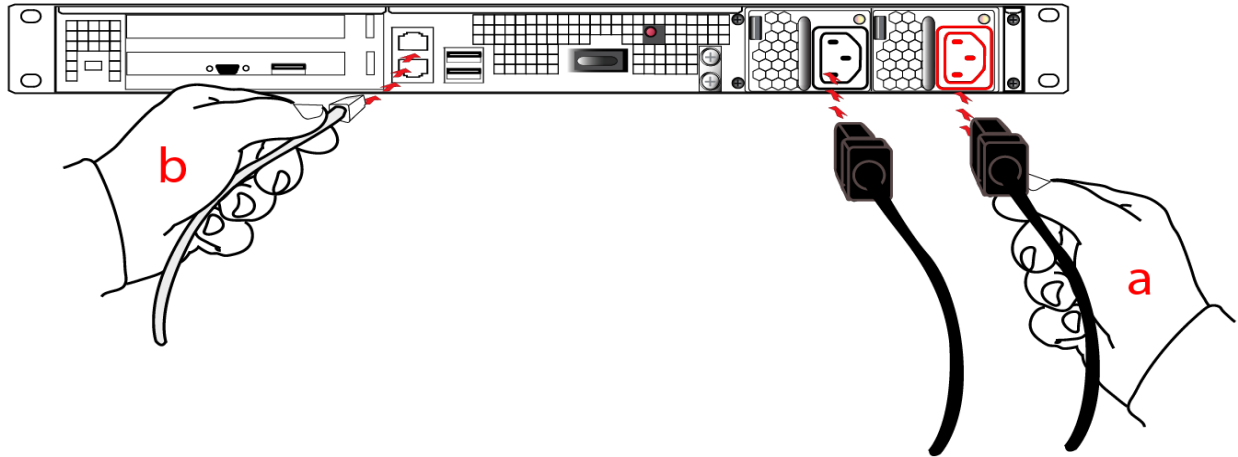

4. Connect the PED at the front panel, using the provided local PED cable – applies only for PED-authenticated HSM, otherwise skip to the next step.



5. Press and release the Start/Stop switch, on the rear panel.

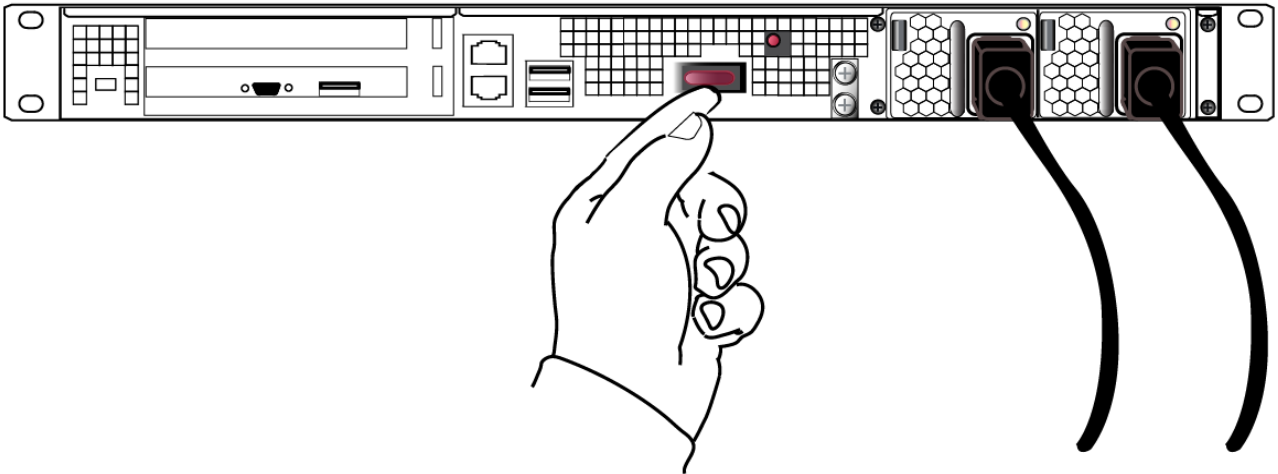

6. Connect a terminal to the serial connector on the front panel.

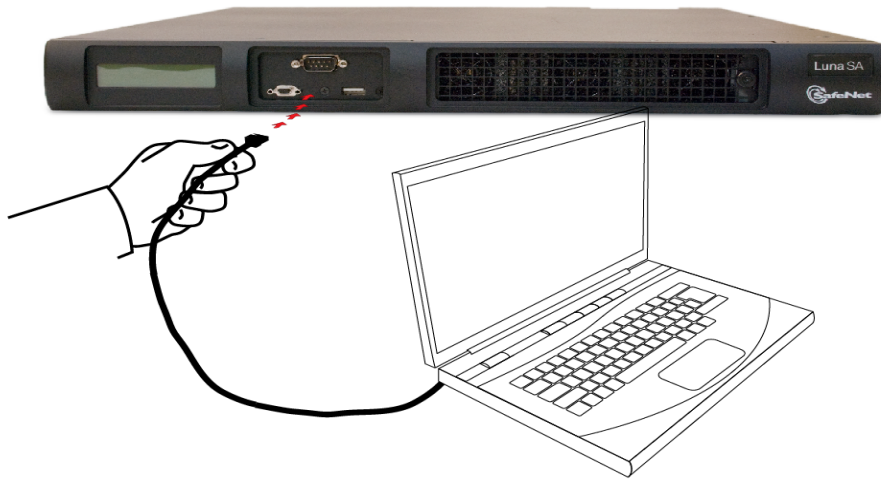

7. If you have already installed SafeNet Client software, go to the Configuration Guide, to configure your SafeNet HSM and peripheral devices, if appropriate.

SafeNet PCIe HSM Hardware Installation

This chapter describes how to install and connect a SafeNet PCIe HSM. To ensure a successful installation, perform the following tasks in the order indicated:

1. Ensure that you have all of the required components, as listed in "[SafeNet PCIe HSM Required Items](#)" on the next [page](#)
2. Install and connect the hardware, as described in "[Installing the SafeNet PCIe HSM Hardware](#)" on page 29

Will SafeNet PCIe HSM work with host computer/server XYZ ?

The SafeNet PCIe HSM has been tested with a variety of representative systems/servers with compliant PCI express slots. When a compatibility problem with a current brand and model computer arises, that information is made available via our Technical Support organization.

If you encounter any issues when installing the SafeNet PCIe HSM into a new server/host computer, first try a different PCI express slot. The design of certain motherboards or the associated BIOS may prevent proper communication with a SafeNet PCIe HSM. For example, certain PCI express physical slots are intended for use only with a video card or another specific type of hardware, and the SafeNet PCIe HSM may not work correctly in these slots.

If you encounter further issues, please contact SafeNet Technical Support.

SafeNet PCIe HSM Required Items

This section provides a list of the components you should have received with your SafeNet PCIe HSM order. The list of items you should have received depends on whether you ordered a password-authenticated SafeNet PCIe HSM or a PED-authenticated SafeNet PCIe HSM, and whether your order included a backup device, as described in the following sections:

Password-Authenticated SafeNet PCIe HSM

The following are the standard items that you should have received as your basic order for a password-authenticated SafeNet PCIe HSM:

SafeNet PCIe HSM

Your order should include one SafeNet PCIe HSM 7000 or SafeNet PCIe HSM 1700 HSM. Both HSM models are physically identical.



Anti-Static Wrist Strap

Your order should include one anti-static wrist strap.



Software and Documentation *

* Software is available by download from Gemalto. Physical media for software and documentation are special-request items.

PED-Authenticated SafeNet PCIe HSM

For local-only operation, where you work at the same computer that contains your PED-Authenticated SafeNet PCIe HSM, you require at least a single, local-only SafeNet PED2. The standard SafeNet PED 2 is capable of local operation only.

If you intend to use Remote PED functions, you will need a SafeNet PED 2 (capable of remote or local PED operation).

If you intend to backup your SafeNet PCIe HSM to a Backup HSM, then you require a SafeNet PED2 to connect to that Backup HSM.

If you intend to combine remote operation and backup, then you should have at least one remote-capable SafeNet PED2 (for remote connection to the SafeNet PCIe HSM). For convenience you might prefer to have a second PED (which can be local-only for the Backup HSM). It is possible to use a single Remote-capable SafeNet PED2 for both connections, and to simply change modes (local or remote mode) as needed.

The following are the items that you receive when you purchase a standard SafeNet PED2 (local-only capable).



Note: You can use SafeNet PEDs and PED Keys that you already own and use with other HSMs – PEDs of the same type and version (v2.3.0 and later) are interchangeable, and PED Keys can be imprinted for use with multiple HSMs if that is appropriate in your context (the only exception is the SRK, which is specific to a single SafeNet PCIe HSM). You should purchase the number you need for your own convenient operation, and for backup/standby units as your security policies might require.

SafeNet PED

Your order should include a PED 2 device. To use PED-authenticated SafeNet HSM with Remote PED function requires a Remote Capable PED – the standard PED does not have the Remote capability. They appear almost identical except for a label “PED Remote” on the front, and the availability of the “Remote” menu when powered on.



PED remote

SafeNet Local PED cable

Your order should include a 9-pin, Micro-D to Micro-D cable for local PED operation.



SafeNet Remote PED cable (Remote PED only)

If you ordered a SafeNet remote PED, your order should include a Type A to Mini B USB cable for remote PED operation.



SafeNet Remote PED Power Supply Kit (Remote PED only *)

If you ordered a SafeNet Remote PED, your order should include a SafeNet Remote PED power supply kit. The power supply is auto-sensing and includes replaceable mains plug modules for international use.



[* If you received a refreshed PED (updated internal hardware, and PED firmware 2.8.0 or newer), it is powered via the USB connection and does not require a separate, external power supply; none is supplied.]

PED Keys and Labels

Your order should include a ten-pack of iKey 1000 blank PED Keys and peel-and-stick labels.

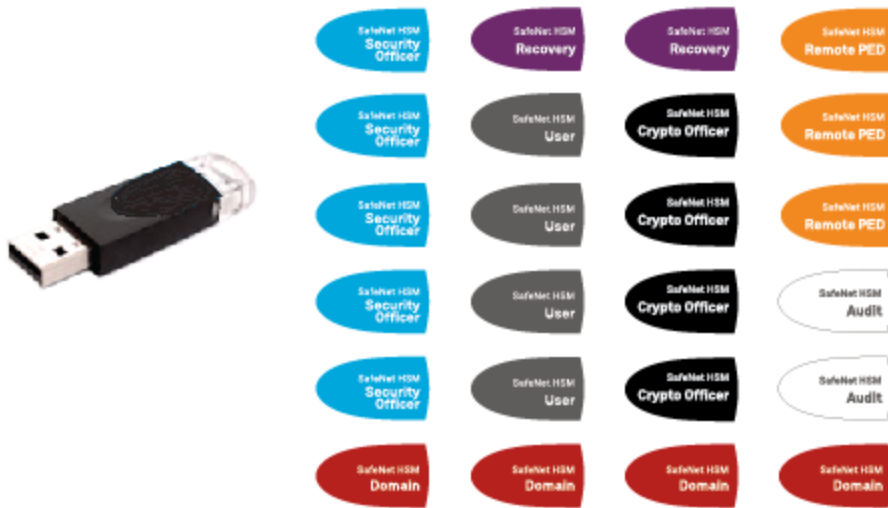

Backup Device

You can back up your selected SafeNet PCIe HSM partition contents (root keys, certificates, other items) to a SafeNet Remote Backup HSM. The SafeNet Remote Backup HSM is a backup-storage option, suitable for off-site storage, and for backing up multiple HSM partitions. The Backup HSM can backup contents of Password authenticated or of PED authenticated HSMs. It must be initialized as one or the other type before the backup operation starts.

The SafeNet Remote Backup HSM can be connected directly to an HSM, or it can be connected to a separate computer to backup remotely located HSMs, in conjunction with Remote PED.

The authentication method for external HSMs must match the authentication method for any internally installed HSM with which they are used (password or PED).

SafeNet Remote Backup HSM

You order might include a SafeNet Remote Backup HSM.



Installing the SafeNet PCIe HSM Hardware

This section describes how to perform the following tasks:

- install the SafeNet PCIe HSM card into the host computer. See ["Installing the SafeNet PCIe HSM Card Into the Host Computer"](#) below.
- connect a local PED, if necessary. See ["Connecting a Local PED"](#) on page 31
- connect a remote PED, if necessary. See ["Connecting a Remote PED"](#) on page 32

Installing the SafeNet PCIe HSM Card Into the Host Computer

You install the SafeNet PCIe HSM card into an open PCIe slot on the host computer.

To install the SafeNet PCIe HSM hardware

1. Open your computer, and remove the slot-cover bracket from an available PCIe slot. If the bracket is secured by a screw, retain that screw.
2. Use the provided anti-static wrist-strap to ground yourself to an exposed metal part of the computer chassis.



3. Remove the SafeNet PCIe HSM 7000 or SafeNet PCIe HSM 1700 from its anti-static packaging and prepare to insert the card into your computer.

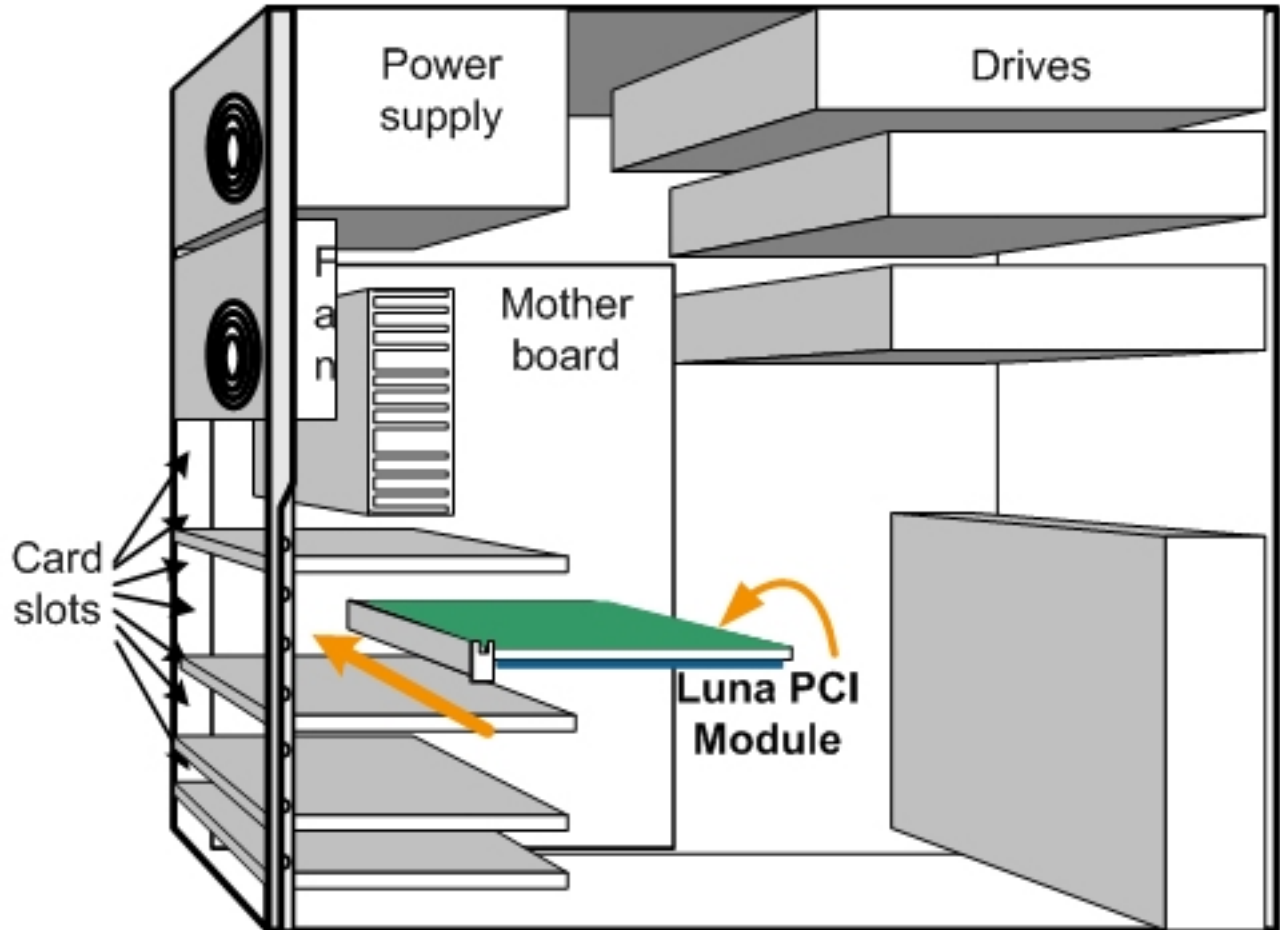

4. Align the SafeNet PCIe HSM card with the vacant slot. You might need to introduce the tip of the card-hold-down bracket first (the silver-metal part along the back edge of the card), in order to properly align the card with the connector. You can use a PCIe X4 or larger slot, as long as it is wired for at least four PCI express channels, and not reserved for a dedicated function. For example, we do not recommend that you use your SafeNet PCIe HSM card in a designated PCI-express video slot - different models of computer and their BIOS firmware can differ in how faithfully they support the PCIe standard.

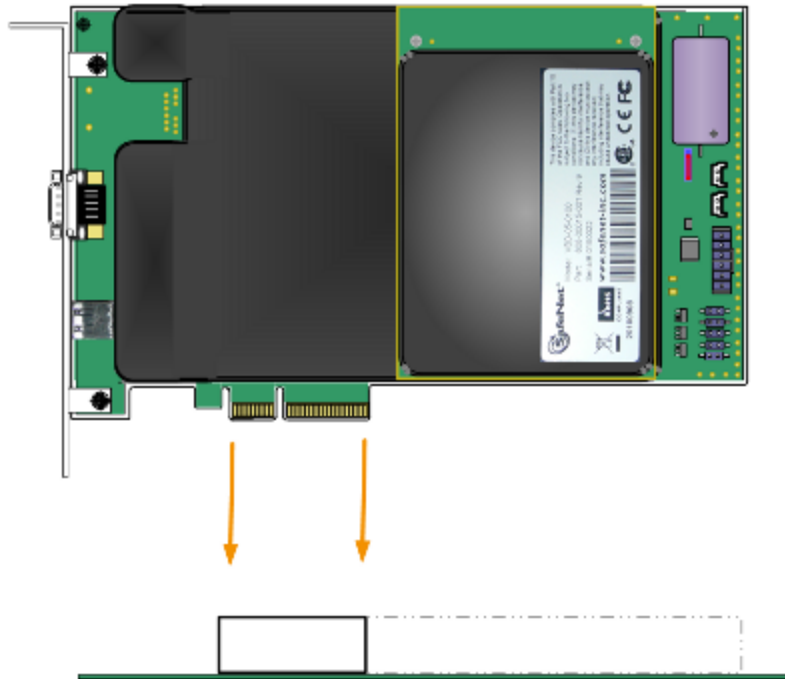

5. Insert the SafeNet PCIe HSM card, gently but firmly, into the connector. It should go straight in – angling the card might cause it to bind. The card is properly seated when no portion of the gold-colored contacts of the card protrudes above the connector socket.

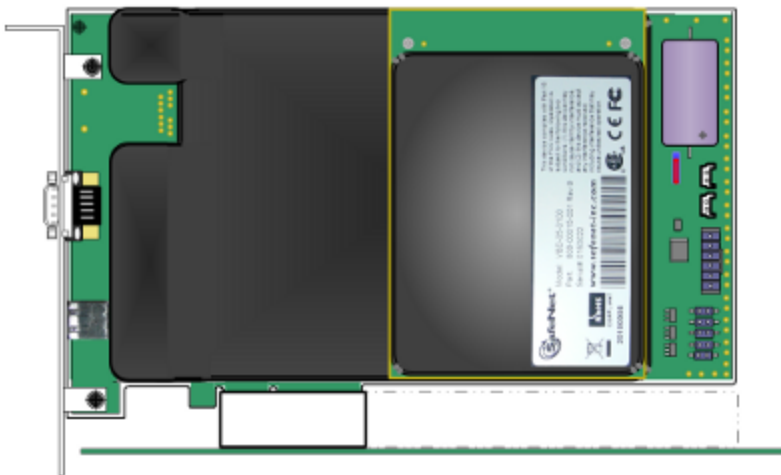

6. Secure the card-hold-down bracket with a screw.
7. Close the computer.

Connecting a Local PED

The local SafeNet PED (or a SafeNet PED Remote used locally) connects directly to the 9-pin Micro-D connector on the SafeNet PCIe HSM card.

To connect a local PED to the SafeNet PCIe HSM

1. Use the SafeNet PED local cable (mini-D-shell 9-pin connectors at both ends) to connect the SafeNet PED to the

SafeNet PCIe HSM card.



Connecting a Remote PED

The Remote-Capable PED can be used either locally, connected directly to a SafeNet HSM (exactly as for the standard PED), or remotely when connected to a suitable workstation and to the electrical main power supply. The normal local use of a PED with Remote PED capability is to use it in local mode to prepare an HSM (imprint an RPK – the orange key with a Remote PED Vector) before shipping it to its remote location. Then you would switch to Remote PED mode.

To prepare an HSM for Remote PED operation you need to connect it locally and imprint the HSM with a Remote PED Key (orange). Once the HSM can be reached via remote desktop connection, and the HSM is associated with an orange PED Key, all further configuration and administration can be performed remotely.

To connect a remote PED to the SafeNet PCIe HSM

1. Use the SafeNet PED local cable to connect the SafeNet PED to the SafeNet PCIe HSM card. This step is required to imprint the HSM with a Remote PED Vector (RPV) using the orange PED key (RPK). This should be the only time you need to connect a PED locally to the HSM. Once the orange PED Key is imprinted with the same RPV as the HSM, all future PED operations can be performed remotely.



2. Follow the instructions in the *Administration Guide* to configure the remote PED. Note that you must install at least the Remote PED optional component of the SafeNet Client software before you can configure the remote PED. See "[SafeNet HSM Client Software Installation](#)" on page 56.

SafeNet USB HSM Hardware Installation

This chapter describes how to install and connect a SafeNet USB HSM. To ensure a successful installation, perform the following tasks in the order indicated:

1. Ensure that you have all of the required components, as listed in "[SafeNet USB HSM Required Items](#)" on the next [page](#)
2. Install the included removable battery, as described in "[Installing the Battery in the SafeNet USB HSM or Backup HSM](#)" on [page 39](#). The SafeNet USB HSM requires the battery to operate.
3. Install and connect the hardware, as described in "[Installing the SafeNet USB HSM Hardware](#)" on [page 41](#)

SafeNet USB HSM Required Items

This section provides a list of the components you should have received with your SafeNet USB HSM order. The list of items you should have received depends on whether you ordered a password-authenticated SafeNet USB HSM or a PED-authenticated SafeNet USB HSM, as described in the following sections:

Password-Authenticated SafeNet USB HSM

The following are the standard items that you should have received as your basic order for a password-authenticated SafeNet USB HSM:

SafeNet USB HSM

Your order should include one SafeNet USB HSM.



Power Cord *

* We no longer ship power cords with the SafeNet HSM products. Please source locally the appropriate standard IT/commercial equipment power cord. We found that many customers order and receive product in one country and then deploy in other countries and regions - too many original-equipment power cords were being discarded as inappropriate for the eventual destination.



USB cable (USB A to USB mini B)

Your order should include one USB A to 5-pin (Mini-B) cable.



Software and Documentation *

* Software is available by download from Gemalto. Physical media for software and documentation are special-request items.

PED-Authenticated SafeNet USB HSM

Depending on your ordering options, the SafeNet USB HSM ships either in secure transport mode or with secure transport mode enabled, but turned off:

- If your SafeNet USB HSM was shipped in secure transport mode, you require the SRK PED Key (purple label) that was shipped separately from your SafeNet USB HSM to unlock your SafeNet USB HSM. Note that each SRK PED keys is specific to a certain SafeNet USB HSM.
- If your SafeNet USB HSM was shipped with secure transport mode enabled, but turned off, no purple key is required initially.

Note that you can use SafeNet PEDs and PED Keys that you already own and use with other HSMs – PEDs of the same type and version (v2.3.0 and later) are interchangeable, and PED Keys can be used with multiple HSMs if that is appropriate in your context (the only exception is the SRK, which is specific to a single SafeNet USB HSM). You should purchase the number you need for your own convenient operation, and for backup/standby units as your security policies might require.

If your SafeNet USB HSM is the PED-authenticated version, then you might also have ordered the items listed below.

SafeNet PED

Your order should include a PED 2 device. To use PED-authenticated SafeNet HSM with Remote PED function requires a Remote Capable PED – the standard PED does not have the Remote capability. They appear almost identical except for a label “PED Remote” on the front, and the availability of the “Remote” menu when powered on.



PED remote

SafeNet Local PED cable

Your order should include a 9-pin, Micro-D to Micro-D cable for local PED operation.



SafeNet Remote PED cable (Remote PED only)

If you ordered a SafeNet remote PED, your order should include a Type A to Mini B USB cable for remote PED operation.



SafeNet Remote PED Power Supply Kit (Remote PED only *)

If you ordered a SafeNet Remote PED, your order should include a SafeNet Remote PED power supply kit. The power supply is auto-sensing and includes replaceable mains plug modules for international use.



[* If you received a refreshed PED (updated internal hardware, and PED firmware 2.8.0 or newer), it is powered via the USB connection and does not require a separate, external power supply; none is supplied.]

PED Keys and Labels

Your order should include a ten-pack of iKey 1000 blank PED Keys and peel-and-stick labels.

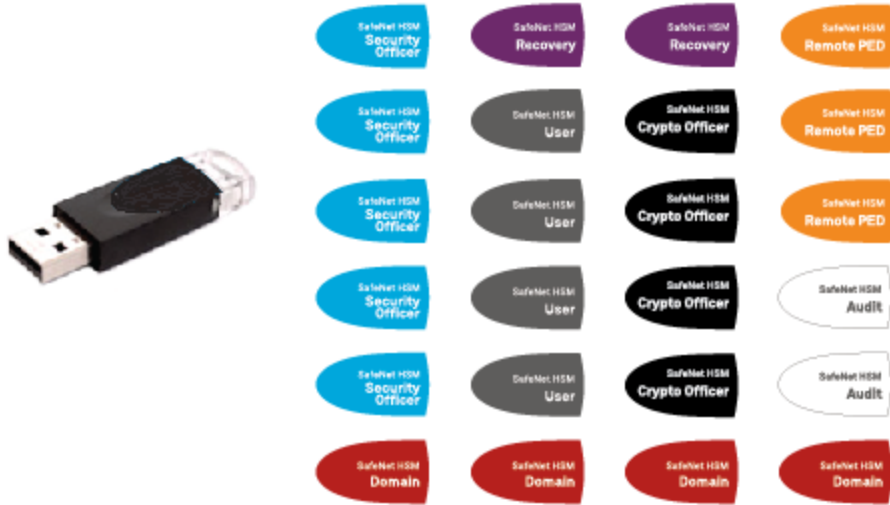

Your order might also include the following optional item.

SafeNet USB HSM Rack-Mount Shelf

The SafeNet SafeNet USB HSM rack-mount shelf (available by separate order) fits a standard 19-inch equipment rack, allowing you to install up to two SafeNet USB HSM units side-by-side in server-room racks. For office use, without rack mounting, SafeNet USB HSM units can be placed on a desktop and are stackable.



Installing the Battery in the SafeNet USB HSM or Backup HSM

The battery is shipped with the SafeNet USB HSM device, but is not installed. You must install the battery before beginning to configure and use the SafeNet USB HSM device.

To install the battery in the SafeNet USB HSM or SafeNet Backup HSM

1. Remove the front faceplate. The faceplate is held in place by two spring clips. Grasp the faceplate firmly and pull to disengage the clips. Set the faceplate aside.



2. The battery compartment is to the right as you face the unit. The compartment cover is circular and has both raised dots and a recessed slot. Use finger-pressure against the dots, or use the edge of a coin in the slot, to twist the battery compartment cover $\frac{1}{4}$ turn in a counter-clockwise direction. The cover should fall out easily.



3. Remove the battery from its packaging and align it at the opening of the SafeNet USB HSM (or SafeNet Backup HSM) battery compartment. The battery should have a "+" sign near the end with the raised nub/bump. The flat end of the battery is the negative pole (-).
4. Insert the battery into the battery compartment, negative end first. The positive end (+) should protrude. The compartment is spring-loaded.



5. Use the battery compartment cover to push the battery into the compartment, against the spring tension. Maintaining the pressure, align the two tabs on the inside of the cover with the two recessed indentations at the top and bottom of the compartment opening. With a little jiggling and a few trial pushes, the tabs should settle into those recesses, allowing the cover to seat flush with the front of the SafeNet USB HSM (or SafeNet Backup HSM). Maintain the inward pressure and twist the cover $\frac{1}{4}$ turn clockwise to lock it in place. The battery is installed.
6. Replace the SafeNet USB HSM (or SafeNet Backup HSM) front-panel by aligning the clips with their respective posts and pushing until the clips grab the posts and the cover snaps in place.



7. The SafeNet USB HSM or SafeNet Backup HSM is ready to connect to your host system.

Installing the SafeNet USB HSM Hardware

This section describes how to mount the SafeNet USB HSM and connect the cables and peripheral devices.

To install the SafeNet USB HSM hardware

1. If you are using the SafeNet SafeNet USB HSM rack-mount shelf, mount the shelf in a suitable equipment rack. Use fasteners appropriate to your brand of equipment rack. The shelf and the SafeNet USB HSM units are light-weight and therefore are adequately secured at the front only. Do not mount more than two SafeNet USB HSM devices, or any non-SafeNet USB HSM equipment, on the shelf.



2. Place your SafeNet USB HSM unit(s) on the shelf and push back until one of the index posts at the back edge of the shelf engages the index hole on the back panel of each SafeNet USB HSM.



3. Insert the power (a) and USB (b) cables at the rear panel.

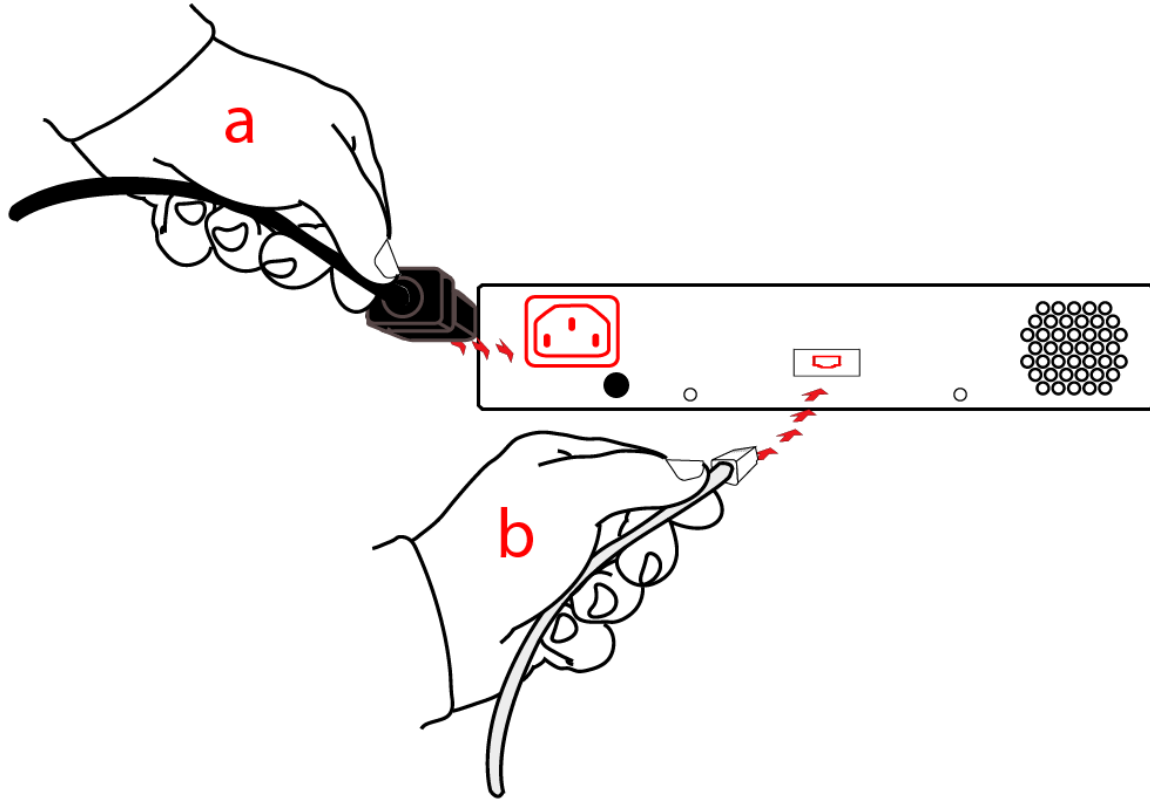

4. If you are installing a PED-authenticated SafeNet USB HSM, connect the PED at the front panel, using the provided local PED cable.



5. Using the USB cable, connect the SafeNet USB HSM to a USB port on the SafeNet HSM client computer.



SafeNet Remote PED Installation and Configuration

This chapter describes how to install, connect, and configure a SafeNet Remote PED. It contains the following sections:

- ["Installing and Configuring a SafeNet Remote PED" on the next page](#)

Installing and Configuring a SafeNet Remote PED

The standard SafeNet PED is intended to connect directly to the HSM, and receives its power, as well as instructions and data via that connection. The Remote PED can act as a local PED, when needed, and connects as described above. When used in Remote PED mode, the SafeNet PED 2 connects to a computer via USB, and therefore requires some additional hardware.

Remote PED can be distinguished from local PED by:

- an orange label **PED Remote** to the right of the SafeNet logo 
- availability of menu item **[7] Remote PED** from the PED's main menu.

Required Items

The following items are included with your Remote PED. All are required for a successful installation.

Quantity	Item
1	SafeNet PED 2 (Remote PED Capable and with firmware 2.4.0-3 or greater) 
1	SafeNet PED Power Supply kit with replaceable mains plug modules for international use (required when the PED is operated in Remote PED mode)

Quantity	Item
	
1	<p>Cable, USB 2.0, Type A to Mini B connectors (for Remote PED operation).</p> 
1	<p>Cable, Data, 9-pin, Micro-D to Micro-D connectors (for local PED operation).</p> 
1	Ten-pack of iKey 1000 PED Keys, and sheets of peel-and-stick labels

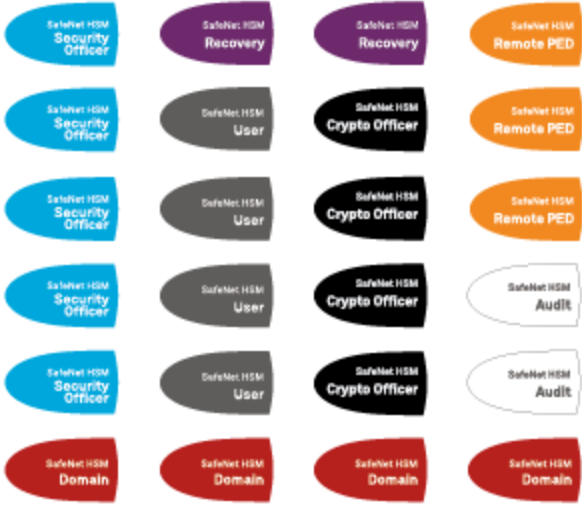
Quantity	Item
	 

Remote PED Setup

The Remote-Capable PED can be used either locally, connected directly to a SafeNet HSM (exactly as for the standard PED), or remotely when connected to a suitable workstation and the electrical main power supply.

The normal local use of a PED with Remote PED capability is to use it in local mode to prepare an HSM. This is done by imprinting an RPV (remote PED vector) onto the HSM and also onto an RPK (the orange Remote PED Key) before shipping the HSM to its remote location. Then the PED can be switched to Remote PED mode, to serve any HSM that has an appropriate RPV.

To configure the remote PED

Step	Action
1	Local OPERATION [Ongoing] To use your HSM appliance and PED for local operation only, refer to the instructions in the Configuration Guide and the HSM Administration Guide.
2	Local OPERATION [Preparing for Remote Use] To prepare an HSM for Remote PED operation, it needs a minimum of preparation as described in this section, below.
3	[Preliminary] From the software media (DVD or downloaded, un-tarred archive file), install the SafeNet HSM Client software, ensuring that Remote PED option is selected, onto the selected Windows computer that will act as the PED server to your remotely located SafeNet HSM, and let the Windows "Found New Hardware" dialog install it. The PedServer.exe and PedClient.exe applications are installed in the SafeNet HSM Client folder along with any other SafeNet tools.
4	[Preliminary] Imprint the HSM with a Remote PED Key (orange); see below. Once the HSM is associated with an orange PED Key, all further configuration and administration can be



Step	Action
	performed remotely.
5	<p>To use the PED locally (for first orange PED Key imprint), connect the PED directly to the PED port of the HSM that you will later be using remotely.</p>  <p>OR</p> <p>OR</p>
6	On power-up, the PED defaults to local mode.



Step	Action
	 <p>Follow the instructions in the SafeNet HSM documentation to:</p> <ul style="list-style-type: none"> • [for SafeNet Network HSM only] log in as “admin” to the appliance (SSH session or local serial connection) • [for SafeNet Network HSM] issue the LunaSH command hsm ped vector init, or [for SafeNet PCIe HSM or SafeNet USB HSM] issue the lunacm command ped vector init, inserting a blank (orange-labeled) PED Key into the PED, when prompted OR inserting an already-imprinted orange PED Key and select “re-use” at the PED prompt • bring the imprinted (orange) Remote PED Key to your workstation, along with a Remote-capable PED • the HSM can now be shipped to its remote locale <p>You can perform other maintenance at this time, if convenient, but only the foregoing steps were required to be done locally - all future configuration and administration can be performed remotely.</p>



To use the Remote PED

Once an HSM has been imprinted with a Remote PED Key (RPK) vector, you can begin administering remotely, while also authenticating remotely from any workstation that has PEDServer software and driver, a remote-capable PED, and an orange PED Key with the correct RPK (that you just imprinted in the previous steps).

Step	Action
1	REMOTE OPERATION Perform the following steps to begin using your computer as a PED Server Workstation, connecting remotely to the distant HSM appliance.
2	[Prepare the PED Power Supply] On the PED power supply, slide the release catch as shown by the heavy arrow, and lift the pin protector (thinner arrow) from the power supply.

Step	Action
	 <p data-bbox="245 747 800 779">The pin protector was used during shipment only.</p>
3	<p data-bbox="245 808 1437 871">Choose a plug style that is appropriate for your country and place it in the power supply, top end first, then snap the bottom end in the direction indicated by the arrow.</p> 
4	<p data-bbox="245 1291 560 1323">For Remote PED operation:</p> <ul data-bbox="245 1333 1404 1396" style="list-style-type: none"><li data-bbox="245 1333 779 1365">• connect the power supply to the AC mains,<li data-bbox="245 1375 1404 1407">• connect the DC power plug of the power supply to the DC power receptacle on the top of the PED,

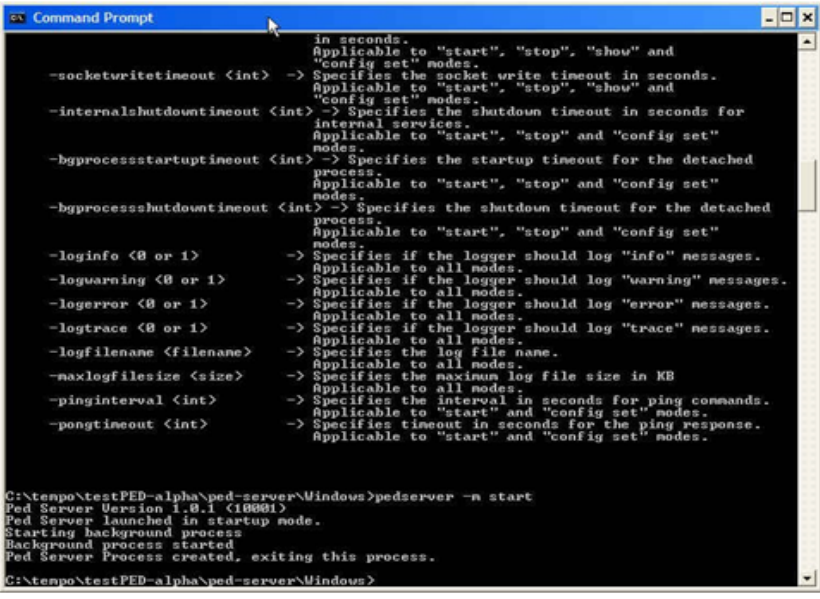
Step	Action
	 <ul style="list-style-type: none"> connect the USB cable between the USB micro connector on the PED and a USB socket on your computer.
5	<p>At the workstation-connected PED:</p> <ul style="list-style-type: none"> press [<] on the PED keypad to exit Local mode,  <ul style="list-style-type: none"> press [7] to enter Remote PED mode.
6	<p>In a command-prompt window on the workstation start the PEDserver program in its listening mode</p> <pre>c:\<yourRemotePED-dir>\pedserver -m start</pre>

Step	Action
	 <pre> in seconds. Applicable to "start", "stop", "show" and "config set" nodes. -socketwritetimeout <int> -> Specifies the socket write timeout in seconds. Applicable to "start", "stop", "show" and "config set" nodes. -internalshutdowntimeout <int> -> Specifies the shutdown timeout in seconds for internal services. Applicable to "start", "stop" and "config set" nodes. -byprocessstartuptimeout <int> -> Specifies the startup timeout for the detached process. Applicable to "start", "stop" and "config set" nodes. -byprocessshutdowntimeout <int> -> Specifies the shutdown timeout for the detached process. Applicable to "start", "stop" and "config set" nodes. -loginfo <0 or 1> -> Specifies if the logger should log "info" messages. Applicable to all nodes. -logwarning <0 or 1> -> Specifies if the logger should log "warning" messages. Applicable to all nodes. -logerror <0 or 1> -> Specifies if the logger should log "error" messages. Applicable to all nodes. -logtrace <0 or 1> -> Specifies if the logger should log "trace" messages. Applicable to all nodes. -logfilename <filename> -> Specifies the log file name. Applicable to all nodes. -maxlogfilesize <size> -> Specifies the maximum log file size in KB Applicable to all nodes. -pinginterval <int> -> Specifies the interval in seconds for ping commands. Applicable to "start" and "config set" nodes. -pongtimeout <int> -> Specifies timeout in seconds for the ping response. Applicable to "start" and "config set" nodes. C:\tempo\testPED-alpha\ped-server\Windows>pedserver -m start Ped Server Version 1.0.1 (10001) Ped Server launched in startup mode. Starting background process Background process started Ped Server Process created, exiting this process. C:\tempo\testPED-alpha\ped-server\Windows> </pre>
7	Run the command <code>pedserver -m show</code> to verify that the PED is detected, and the system is ready for remote connection.
8	<p>Start the PED Client - the Remote PED enabling process on the HSM host(for example):</p> <pre>lunash:> hsm ped connect -ip 192.2.12.16 - port 1503</pre> <p>or</p> <pre>lunacm:> ped connect -ip 192.2.12.16 - port 1503</pre> <p>The Remote PED Client in the HSM appliance connects with the listening PEDserver (your workstation).</p>
9	<p>Perform an hsm login or role login -name SO (as appropriate. The PED prompts first for the Remote PED Key. Insert the imprinted Remote PED Key associated with the connecting HSM appliance, and press [Enter].</p> 

Step	Action
	Then the PED prompts for the HSM SO's blue PED Key. Insert that and press [Enter]. A successful login confirms that the Remote PED connection is running properly.
10	Begin using and administering the remotely located SafeNet HSM appliance via ssh session, and providing PED Key authentication via the workstation-connected Remote PED, whenever requested. Review the SafeNet Network HSM Help for information about timeouts with respect to Remote PED.



Note: Remote PED is served from a host computer running LunaClient PEDServer software. A Remote PED session is called by an instance of PEDClient running on the computer hosting the SafeNet HSM. In some cases, such as SafeNet Network HSMs behind strict firewalls, the HSM host is not allowed to initiate the connection. In that case, you can initiate a Remote PED session from the PEDServer side, providing that the computer hosting the PED has obtained and registered the SafeNet Network HSM's server.pem certificate.

SafeNet HSM Client Software Installation

This chapter describes how to install the SafeNet HSM Client software. After installing the hardware, you need to install the SafeNet Client software, as follows, before you can begin configuring your SafeNet HSM(s):

- For SafeNet Network HSM, install the SafeNet Client on any computer that must connect to the appliance as a client.
- For SafeNet PCIe HSM, install the SafeNet Client on the workstation into which the SafeNet PCIe HSM is installed.
- For SafeNet USB HSM, install the SafeNet Client on the workstation to which the SafeNet Luna USB HSM is connected.
- Install the SafeNet Client on any computer that is to have a SafeNet Remote PED connected.

Choose the instructions for your operating system:

- For AIX, see "[AIX SafeNet HSM Client Installation](#)" on the next page.
- For HP-UX, see "[HP-UX SafeNet HSM Client Installation](#)" on page 63.
- For Linux, see "[Linux SafeNet HSM Client Installation](#)" on page 69.
- For Solaris, see "[Solaris SafeNet HSM Client Installation](#)" on page 79
- For Windows, see "[Windows SafeNet HSM Client Installation](#)" on page 84 The following supplemental topics also apply to Windows:
 - "[Windows Server 2012 SafeNet HSM Client Supplemental Configuration](#)" on page 97
 - "[Scripted / Unattended Installation on Windows](#)" on page 101



Note: Not all operating systems are supported for each SafeNet HSM type. Refer to the Customer Release Notes (see "[Customer Release Notes](#)" on page 8) for the most current information on supported platforms.

AIX SafeNet HSM Client Installation

These instructions assume that you have already acquired the SafeNet Client software, either on DVD or in the form of a downloaded .tar archive. Applicability to specific versions of AIX is summarized in the Customer Release Notes for the current release.



Note: Before installing a SafeNet system, you should confirm that the product you have received is in factory condition and has not been tampered with in transit. Refer to the Content Sheet included with your product shipment. If you have any questions about the condition of the product that you have received, please contact SafeNet Support.

Each computer that connects to the SafeNet HSM appliance as a Client must have the cryptoki library, the vtl client shell and other utilities and supporting files installed. Each computer that contains, or is connected to a SafeNet USB HSM or a SafeNet PCIe HSM must have the cryptoki library and other utilities and supporting files installed.



Note: This example shows all the SafeNet Client products and components. Some items are not supported on all operating systems and therefore do not appear as you proceed through the installation script.

Do not install SafeNet client software on the same system as legacy SafeNet CA³, SafeNet CA4, SafeNet PCM, or SafeNet PCI software. The software is intended for modern/current SafeNet HSMs, SafeNet Network HSM, SafeNet PCIe HSM, SafeNet USB HSM, SafeNet (Remote) Backup HSM.

Prerequisites

Before starting the installation, ensure that you have a Random Number Generator (RNG) or Entropy Gathering Daemon (EGD) on your system in one of the following locations:

- /dev/egd-pool
- /etc/egd-pool
- /etc/entropy
- /var/run/egd-pool

RNG/EGD

Cryptographic algorithms, including those that assure the security of communication – such as in OpenSSL and other protocols – depend upon random numbers for the creation of strong keys and certificates. A readily available source of random data is the entropy that exists in complex computer processes. Utilities exist for every operating system, to gather bits of system entropy into a pool, which can then be used by other processes.

Windows and Linux have these installed by default. Other systems might or might not. See your system administrator.

You Need an Entropy Pool

In the case of SafeNet Network HSM, the SafeNet Client administration tool (vtl) expects to find a source of randomness at **/dev/random**. If one is not found, **vtl** fails, because the link cannot be secured from the Client end.

If your system does have an entropy pool, but the random number generator (RNG) is not in the expected place, then you can create a symbolic link between the actual location and one of the following:

- /dev/random
- /dev/egd-pool
- /etc/egd-pool
- /etc/entropy
- /var/run/egd-pool

If your system does not have an entropy gathering daemon or random number generator, please direct your system administrator to install one, and point it to one of the named devices.

Packages Required to Build the Driver on G5, PCIe, and Remote Backup HSM Clients

If you are installing the SafeNet PCIe HSM, or SafeNet USB HSM, or SafeNet Remote Backup HSM clients, ensure that the following items are installed:

- Kernel headers for build
- rpm-build package
- C and C++ compilers
- make command

These items are required because the driver module is built on Linux before it is installed. If one of these items is missing, the driver build will fail and the module will not get installed.

Installing the Client Software

Check the SafeNet HSM Customer Release Notes for any installation-related issues or instructions before you begin the following software installation process.



CAUTION: You must be logged in as **root** when you run the installation script.

To install the SafeNet Client software on AIX

1. Log on to the client system, open a console or terminal window, and use **su** to gain administrative permissions for the installation.
2. If you have downloaded the SafeNet Client software as a .tar archive, skip to step 6.
3. Insert the DVD (mount it if you do not have automount).
4. Go to the DVD (/cdrom or whatever devicename your system uses) and the install directory:

32-bit OS	cd /cdrom/AIX/32
64-bit OS	cd /cdrom/AIX/64



Note: Not all platforms are supported with each release, so the available install options might not match the list above.

5. Skip to step 9.
6. If you downloaded the software, copy or move the .tar archive (which usually has a name like "Luna Client_6.x.y-nn.tar") to a suitable directory where you can untar the archive and launch the installation script.

7. Enter the following command to extract the contents from the archive:

```
tar xvf SafeNet Client<version>.tar
```

8. Change directory to the software version suitable for your system (for example, under the "aix" subdirectory, choose 32-bit or 64-bit according to your system requirement).

9. Install the client software as follows:

- To see the 'help', or a list of available installer options, type:

```
sh install.sh -? or ./sh install.sh --help
```

- To install all available products and optional components, type:

```
sh install.sh all
```

- To selectively install individual products and optional components, type the command without arguments:

```
sh install.sh
```

10. Type "y" if you agree to be bound by the license agreement:

```
[mylunaclient-1 32]$ sh install.sh
```

```
IMPORTANT: The terms and conditions of use outlined in the software
license agreement (Document #008-010005-001_053110) shipped with the product
("License") constitute a legal agreement between you and SafeNet Incorporated.
Please read the License contained in the packaging of this
product in its entirety before installing this product.
```

```
Do you agree to the License contained in the product packaging?
```

```
If you select 'yes' or 'y' you agree to be bound by all the terms
and conditions set out in the License.
```

```
If you select 'no' or 'n', this product will not be installed.
```

```
(y/n)
```

11. A list of installable SafeNet products appears (might be different, depending on your platform). Select as many as you require, by typing the number of each (in any order) and pressing Enter. As each item is selected, the list updates, with a "*" in front of any item that has been selected. This example shows item 1 has been selected.

```
Products
```

```
Choose Luna Products to be installed
```

```
*[1]: SafeNet Network HSM
```

```
[2]: SafeNet PCIe HSM
```

```
[N|n]: Next
```

```
[Q|q]: Quit
```

```
Enter selection: 2
```



Note: When the above was captured, AIX supported only SafeNet Network HSM and SafeNet PCIe HSM among SafeNet HSM products. To install SafeNet USB HSM or the SafeNet Remote Backup HSM, you will need one of the other supported host platforms.

12. When selection is complete, type "N" or "n" for "Next", and press Enter. If you wish to make a change, simply type a number again and press Enter to de-select a single item.

13. The next list is called "Advanced" and includes additional items to install. Some items might be pre-selected to provide the optimum SafeNet HSM experience for the majority of customers, but you can change any selection in the list.

```

Products
Choose Luna Products to be installed
*[1]: SafeNet Network HSM
  [2]: SafeNet PCIe HSM
  [N|n]: Next
  [Q|q]: Quit
Enter selection: n

```

If you wish to make a change, simply type a number again and press Enter to de-select a single item.

If the script detects an existing cryptoki library, it stops and suggests that you uninstall your previous SafeNet software before starting the SafeNet Client installation again.

14. The system installs all packages related to the products and any optional components that you selected. By default, the Client programs are installed in the **/usr/safenet/lunaclient** directory.



Note: When installing, ensure that the full path of a package does not contain any space characters. (The IBM examples do not show any spaces, implying that this might be a system requirement.)

As a general rule, do not modify the `Chrystoki.conf/crystoki.ini` file, unless directed to do so by SafeNet Customer Support. If you do modify the file, never insert TAB characters - use individual space characters. Avoid modifying the PED timeout settings. These are now hardcoded in the appliance, but the numbers in the `Chrystoki.conf` file must match.

Uninstalling the SafeNet Client Software

You may need to uninstall the SafeNet Client software prior to upgrading to a new release, or if the software is no longer required. You must be logged in as root.

To uninstall the SafeNet HSM client software

1. Log in as root.
2. Go to the client installation directory:
cd /usr/safenet/lunaclient/bin
3. Run the uninstall script:
sh uninstall.sh

Java Component Installation

During the installation, the script provides the opportunity to install SafeNet Java components. If you select Java components, the SafeNet Java files are installed in the **/usr/safenet/lunaclient/jsp/** directory. In order to use Java, you must have separately installed Java (JDK or run-time environment from the vendor of your choice) onto your system.

Copy the SafeNet Java library and jar files from their default location under **/usr/safenet/lunaclient/jsp/lib** to the Java environment directory, for example **/usr/jre/lib/ext**. The exact directory might differ depending on where you obtained your Java system, the version, and any choices that you made while installing and configuring it.

For additional Java-related information, see "[Java Interfaces](#)" on [page 1](#) in the *SDK Reference Guide*.

JSP Static Registration

You would choose static registration of providers if you want all applications to default to our (SafeNet) provider.

Once your client has externally logged in using `salogin` (see) in the Reference section of this document) or your own HSM-aware utility, any application would be able to use SafeNet product without being designed to login to the HSM Partition.

Edit the `java.security` file located in the `\jre\lib\security` directory of your Java SDK/JRE 7 or 8 installation to read as follows:

```
security.provider.1=sun.security.provider.Sun
security.provider.2=com.sun.net.ssl.internal.ssl.Provider
security.provider.3=com.safenetinc.luna.provider.LunaProvider
security.provider.4=com.sun.rsa.jca.Provider
security.provider.5=com.sun.crypto.provider.SunJCE
security.provider.6=sun.security.jgss.SunProvider
```

You can set our provider in first position for efficiency if SafeNet HSM operations are your primary mode. However, if your application needs to perform operations not supported by the `LunaProvider` (secure random generation or random publickey verification, for example) then it would receive error messages from the HSM and would need to handle those gracefully before resorting to providers further down the list. We have found that having our provider in third position works well for most applications.

The modifications in the "java.security" file are global, and they might result in the breaking of another application that uses the default `KeyPairGenerator` without logging into the SafeNet Network HSM first. This consideration might argue for using dynamic registration, instead.

JSP Dynamic Registration

For your situation, you may prefer to employ dynamic registration of Providers, in order to avoid possible negative impacts on other applications running on the same machine. As well, the use of dynamic registration allows you to keep installation as straightforward as possible for your customers.

Compatibility

We formally test SafeNet HSMs and our Java provider with SUN JDK for all platforms except AIX, and with IBM JDK for the AIX platform. We have not had problems with OpenJDK, although it has not been part of our formal test suite. The SafeNet JCE provider is compliant with the JCE specification, and should work with any JVM that implements the Java language specification.

Occasional problems have been encountered with respect to IBM JSSE.

GNU JDK shipped with most Linux systems has historically been incomplete and not suitable.

Removing Components

To uninstall the JSP component or the SDK component, you must uninstall SafeNet Client completely (see ["Uninstalling the SafeNet Client Software" on the previous page](#), then re-run the installation script without selecting the unwanted component(s).

Interrupting the Installation

Do not interrupt the installation script in progress, and ensure that your host computer is served by an uninterruptible power supply (UPS). If you press [Ctrl] [C], or otherwise interrupt the installation (OS problem, power outage, other), some components will not be installed. It is not possible to resume an interrupted install process. The result of an

interruption depends on where, in the process, the interruption occurred (what remained to install before the process was stopped).

As long as the cryptoki RPM package is installed, any subsequent installation attempt results in refusal with the message "A version of Luna Client is already installed."

If components are missing or are not working properly after an interrupted installation, or if you wish to install any additional components at a later date (following an interrupted installation, as described), you would need to uninstall everything first. If 'sh uninstall.sh' is unable to do it, then you must uninstall all packages manually.

Because interruption of the install.sh script is not recommended, and mitigation is possible, this is considered a low-likelihood corner case, fully addressed by these comments.

After Installation

When you have installed the software onto a Client, the next task is to configure the SafeNet HSM, as described in the *Configuration Guide*.

HP-UX SafeNet HSM Client Installation

These instructions assume that you have already acquired the SafeNet HSM Client software, either on CD/DVD or in the form of a downloaded .tar archive. Applicability to specific versions of HP-UX is summarized in the Customer Release Notes for the current release. See "[Customer Release Notes](#)" on page 8 for more information.



Note: Before installing a SafeNet system, you should confirm that the product you have received is in factory condition and has not been tampered with in transit. Refer to the Content Sheet included with your product shipment. If you have any questions about the condition of the product that you have received, please contact SafeNet Support.

Each computer that connects to the SafeNet HSM appliance as a Client must have the cryptoki library, the vtl client shell and other utilities and supporting files installed. Each computer that contains, or is connected to, a SafeNet USB HSM or a SafeNet PCIe HSM must have the cryptoki library and other utilities and supporting files installed.



Note: This example shows all the SafeNet Client products and components. Some items are not supported on all operating systems and therefore do not appear as you proceed through the installation script.

Do not install SafeNet client software on the same system as legacy SafeNet CA³, SafeNet CA4, SafeNet PCM, or SafeNet PCI software. The software is intended for modern/current SafeNet HSMs, SafeNet Network HSM, SafeNet PCIe HSM, SafeNet USB HSM, SafeNet (Remote) Backup HSM.

Prerequisites

Before starting the installation, ensure that you have a Random Number Generator (RNG) or Entropy Gathering Daemon (EGD) on your system in one of the following locations:

- /dev/egd-pool
- /etc/egd-pool
- /etc/entropy
- /var/run/egd-pool

RNG/EGD

Cryptographic algorithms, including those that assure the security of communication – such as in OpenSSL and other protocols – depend upon random numbers for the creation of strong keys and certificates. A readily available source of random data is the entropy that exists in complex computer processes. Utilities exist for every operating system, to gather bits of system entropy into a pool, which can then be used by other processes.

Windows and Linux have these installed by default. Other systems might or might not. See your system administrator.

You Need an Entropy Pool

In the case of SafeNet Network HSM, the SafeNet Client administration tool (vtl) expects to find a source of randomness at **/dev/random**. If one is not found, **vtl** fails, because the link cannot be secured from the Client end.

If your system does have an entropy pool, but the random number generator (RNG) is not in the expected place, then you can create a symbolic link between the actual location and one of the following:

- /dev/random
- /dev/egd-pool
- /etc/egd-pool
- /etc/entropy
- /var/run/egd-pool

If your system does not have an entropy gathering daemon or random number generator, please direct your system administrator to install one, and point it to one of the named devices.

Installing the SafeNet HSM Client Software

Check the SafeNet HSM Customer Release Notes for any installation-related issues or instructions before you begin the following software installation process.



CAUTION: You must be logged in as **root** when you run the installation script.

To install the SafeNet HSM Client software on HP-UX

1. Log on to the client system, open a console or terminal window, and use **su** to gain administrative permissions for the installation.
2. If you have downloaded the SafeNet Client software as a .tar archive, skip to step 6.
3. Insert the SafeNet Client software DVD (mount it if you do not have automount).
4. Go to the DVD (/cdrom or whatever device name your system uses) and the install directory for your architecture, for example:

32-bit OS	cd /cdrom/hpux/IA/32
64-bit OS	cd /cdrom/hpux/IA/64

5. Skip to step 9.
6. If you downloaded the software, copy or move the .tar archive (which usually has a name like "Luna Client_5.x.y-nn.tar") to a suitable directory where you can untar the archive and launch the installation script.
7. Enter the following command to extract the contents from the archive:

```
tar xvf SafeNet Client<version>.tar
```
8. Change directory to the software version suitable for your system (for example, under the "hpux" subdirectory, in the "x86" directory, choose 32-bit or 64-bit according to your system requirement).
9. Install the client software as follows:
 - To see the help, or a list of available installer options, type:

```
sh install.sh -? or sh install.sh --help
```
 - To install all available products and optional components, type:

```
sh install.sh all
```

- To selectively install individual products and optional components, type the command without arguments:

```
sh install.sh
```

10. Type **y** if you agree to be bound by the license agreement:

```
[mylunaclient-1 32]$ sh install.sh
```

```
IMPORTANT: The terms and conditions of use outlined in the software
license agreement (Document #008-010005-001_053110) shipped with the product
("License") constitute a legal agreement between you and SafeNet Incorporated.
Please read the License contained in the packaging of this
product in its entirety before installing this product.
```

```
Do you agree to the License contained in the product packaging?
```

```
If you select 'yes' or 'y' you agree to be bound by all the terms
and conditions set out in the License.
```

```
If you select 'no' or 'n', this product will not be installed.
```

```
(y/n)
```

11. A list of installable SafeNet products appears (might be different, depending on your platform). Select as many as you require, by typing the number of each (in any order) and pressing [Enter]. As each item is selected, the list updates, with a "*" in front of any item that has been selected. This example shows item 1 has been selected, and item 2 is about to be selected:

```
Products
Choose Luna Products to be installed
*[1]: SafeNet Network HSM
  [2]: SafeNet PCIe HSM
  [N|n]: Next
  [Q|q]: Quit
Enter selection: 2
```



Note: When the above was captured, HP-UX supported only SafeNet Network HSM and SafeNet PCIe HSM among SafeNet HSM products. To install SafeNet USB HSM or the SafeNet Remote Backup HSM, you will need one of the other supported host platforms.

12. When selection is complete, type "N" or "n" for "Next", and press Enter. If you wish to make a change, simply type a number again and press Enter to de-select a single item.
13. The next list is called **Advanced** and includes additional items to install. Some items might be pre-selected to provide the optimum SafeNet HSM experience for the majority of customers, but you can change any selection in the list.

```
Products
Choose Luna Components to be installed
  [1]: Luna Software Development Kit (SDK)
*[2]: Luna JSP (Java)
*[3]: Luna JCPProv (Java)
*[4]: Crypto Command Center Provisioning Client
*[5]: Luna SNMP subagent
  [B|b]: Back to Products Selection
  [I|i]: Install
  [Q|q]: Quit
Enter selection: n
```

When the Components list is adjusted to your satisfaction, press Enter.



Note: The installer includes the SafeNet SNMP Subagent as an option. After installation is complete, you will need to move the SafeNet MIB files to the appropriate directory for your SNMP application, and you will need to start the SafeNet subagent and configure for use with your agent. See the *Administration Guide* for more information.

If the script detects an existing cryptoki library, it stops and suggests that you uninstall your previous SafeNet software before starting the SafeNet Client installation again.

14. The system installs all packages related to the products and any optional components that you selected. By default, the Client programs are installed in the **/opt/safenet/lunaclient** directory.

As a general rule, do not modify the `Chrystoki.conf/crystoki.ini` file, unless directed to do so by SafeNet Customer Support. If you do modify the file, never insert TAB characters - use individual space characters. Avoid modifying the PED timeout settings. These are now hardcoded in the appliance, but the numbers in the `Chrystoki.conf` file must match.

Uninstalling the SafeNet HSM Client Software

You may need to uninstall the SafeNet Client software prior to upgrading to a new release, or if the software is no longer required. You must be logged in as root.

To uninstall the SafeNet HSM client software

1. Log in as root.
2. Go to the client installation directory:
cd /opt/safenet/lunaclient/bin
3. Run the uninstall script:
sh uninstall.sh

Java Component Installation

During the installation, the script provides the opportunity to install SafeNet Java components. If you select Java components, the SafeNet Java files are installed in the **/opt/safenet/lunaclient/jsp/** directory. In order to use Java, you must have separately installed Java (JDK or run-time environment from the vendor of your choice) onto your system.

Copy the SafeNet Java library and jar files from their default location under **/opt/safenet/lunaclient/jsp/lib** to the Java environment directory, for example **/opt/jre/lib/ext**. The exact directory might differ depending on where you obtained your Java system, the version, and any choices that you made while installing and configuring it.

For additional Java-related information, see "[Java Interfaces](#)" on [page 1](#) in the *SDK Reference Guide*

JSP Static Registration

You would choose static registration of providers if you want all applications to default to our (SafeNet) provider.

Once your client has externally logged in using `salogin` (see) in the Reference section of this document) or your own HSM-aware utility, any application would be able to use SafeNet product without being designed to login to the HSM Partition.

Edit the `java.security` file located in the `\jre\lib\security` directory of your Java SDK/JRE 7 or 8 installation to read as follows:

```
security.provider.1=sun.security.provider.Sun
security.provider.2=com.sun.net.ssl.internal.ssl.Provider
security.provider.3=com.safenetinc.luna.provider.LunaProvider
security.provider.4=com.sun.rsajca.Provider
security.provider.5=com.sun.crypto.provider.SunJCE
security.provider.6=sun.security.jgss.SunProvider
```

You can set our provider in first position for efficiency if SafeNet HSM operations are your primary mode. However, if your application needs to perform operations not supported by the `LunaProvider` (secure random generation or random publickey verification, for example) then it would receive error messages from the HSM and would need to handle those gracefully before resorting to providers further down the list. We have found that having our provider in third position works well for most applications.

The modifications in the "java.security" file are global, and they might result in the breaking of another application that uses the default `KeyPairGenerator` without logging into the SafeNet Network HSM first. This consideration might argue for using dynamic registration, instead.

JSP Dynamic Registration

For your situation, you may prefer to employ dynamic registration of Providers, in order to avoid possible negative impacts on other applications running on the same machine. As well, the use of dynamic registration allows you to keep installation as straightforward as possible for your customers.

Compatibility

We formally test SafeNet HSMs and our Java provider with SUN JDK for all platforms except AIX, and with IBM JDK for the AIX platform. We have not had problems with OpenJDK, although it has not been part of our formal test suite. The SafeNet JCE provider is compliant with the JCE specification, and should work with any JVM that implements the Java language specification.

Occasional problems have been encountered with respect to IBM JSSE.

GNU JDK shipped with most Linux systems has historically been incomplete and not suitable.

Removing Components

To uninstall the JSP component or the SDK component, you must uninstall SafeNet Client completely (see "[HP-UX SafeNet HSM Client Installation](#)" on page 63), then re-run the installation script without selecting the unwanted component(s).

Interrupting the Installation

Do not interrupt the installation script in progress, and ensure that your host computer is served by an uninterruptible power supply (UPS). If you press [Ctrl] [C], or otherwise interrupt the installation (OS problem, power outage, other), some components will not be installed. It is not possible to resume an interrupted install process. The result of an interruption depends on where, in the process, the interruption occurred (what remained to install before the process was stopped).

As long as the `cryptoki` RPM package is installed, any subsequent installation attempt results in refusal with the message "A version of SafeNet Client is already installed."

If components are missing or are not working properly after an interrupted installation, or if you wish to install any additional components at a later date (following an interrupted installation, as described), you would need to uninstall everything first. If 'sh uninstall.sh' is unable to do it, then you must uninstall all packages manually.

Because interruption of the install.sh script is not recommended, and mitigation is possible, this is considered a low-likelihood corner case, fully addressed by these comments.

After Installation

When you have installed the software onto a Client, the next task is to configure the SafeNet HSM, as described in the *Configuration Guide*.

Linux SafeNet HSM Client Installation

These instructions are tested for the Linux versions listed in the Customer Release Notes.

These instructions assume that you have already acquired the SafeNet Client software, either on CD/DVD or in the form of a downloaded .tar archive.

Applicability to specific versions of Linux is summarized in the Customer Release Notes for the current release.



Note: Before installing a Luna® system, confirm that the product you have received is in factory condition and has not been tampered with in transit. Refer to the Startup Guide included with your product shipment. If you have any questions about the condition of the product that you have received, please contact SafeNet Support (800)545 6608 or support@safenet-inc.com immediately

Each computer that connects to the SafeNet HSM appliance as a Client must have the cryptoki library, the vtl client shell and other utilities and supporting files installed.

Each computer that contains, or is connected to a SafeNet USB HSM or a SafeNet PCIe HSM must have the cryptoki library and other utilities and supporting files installed.



Note: This example shows all the SafeNet Client products and components. Some items are not supported on all operating systems and therefore do not appear as you proceed through the installation script.

Do not install SafeNet client software on the same system as legacy SafeNet CA³, SafeNet CA4, SafeNet PCM, or SafeNet PCI software. The software is intended for modern/current SafeNet HSMs, SafeNet Network HSM, SafeNet PCIe HSM, SafeNet USB HSM, SafeNet (Remote) Backup HSM.

Prerequisites

Before starting the installation, ensure that you have satisfied the following prerequisites:

Random Number Generator (RNG) or Entropy Gathering Daemon (EGD)

Ensure that you have a Random Number Generator (RNG) or Entropy Gathering Daemon (EGD) on your system in one of the following locations:

- /dev/egd-pool
- /etc/egd-pool,
- /etc/entropy
- /var/run/egd-pool

RNG/EGD

Cryptographic algorithms, including those that assure the security of communication – such as in OpenSSL and other protocols – depend upon random numbers for the creation of strong keys and certificates. A readily available source of random data is the entropy that exists in complex computer processes. Utilities exist for every operating system, to gather bits of system entropy into a pool, which can then be used by other processes.

Windows and Linux have these installed by default. Other systems may or may not. See your system administrator.

You Need an Entropy Pool

In the case of SafeNet Network HSM, the SafeNet Client administration tool (**vtl**) expects to find a source of randomness at **/dev/random**. If one is not found, **vtl** fails, because the link cannot be secured from the Client end.

If your system does have an entropy pool, but the random number generator (RNG) is not in the expected place, then you can create a symbolic link between the actual location and one of the following:

- `/dev/random`
- `/dev/egd-pool`
- `/etc/egd-pool`
- `/etc/entropy`
- `/var/run/egd-pool`

If your system does not have an entropy gathering daemon or random number generator, please direct your system administrator to install one, and point it to one of the named devices.

Alien with Debian

The SafeNet Client software is provided as RPM packages. If you are installing on a Debian system, you must have "alien" installed before beginning the SafeNet Client installation. The SafeNet Client installation script invokes the alien conversion of RPMs to DEB packages. The install script will stop with a message if you attempt to install on a Debian system without the alien package already installed.

Components Used to Build the Driver (SafeNet USB HSM, PCIe, and Remote Backup HSM)

If you are installing the SafeNet PCIe HSM, or SafeNet USB HSM, or SafeNet Remote Backup HSM clients, ensure that the following items are installed:

- Kernel headers for build
- rpm-build package
- C and C++ compilers
- make command

These items are required because the driver module is built on Linux before it is installed. If one of these items is missing, the driver build will fail and the module will not be installed..

Installing the Client Software

It is recommended that you refer to the SafeNet HSM Customer Release Notes for any installation-related issues or instructions before you begin the following software installation process.



CAUTION: You must be logged in as **root** when you run the installation script.

By default, the Client programs are installed in the `"/usr/safenet/lunaclient"` directory.

To install the SafeNet HSM client software on a Linux workstation

1. Log on to the client system, open a console or terminal window, and use **sudo** to gain administrative permissions for the installation.
2. If you have downloaded the SafeNet Client software as a `.tar` archive, skip to step 6.

3. Insert the DVD (mount it if you do not have automount).
4. Go to the DVD (`/cdrom` or whatever devicename your system uses) and the install directory for your architecture:

```
cd /cdrom/linux/32
```

or

```
cd /cdrom/linux/64
```



Note: Not all platforms are supported with each release, so the available install options might not match the list above.

5. Skip to step 9.
6. If you downloaded the software, copy or move the `.tar` archive (which usually has a name like "Luna Client_5.x.y-nn.tar") to a suitable directory where you can untar the archive and launch the installation script.
7. Extract the contents from the archive:

```
tar xvf <filename>.tar
```
8. Change directory to the software version suitable for your system (for example, under the `linux` subdirectory, in the `x86` directory, choose 32-bit or 64-bit according to your system requirement).

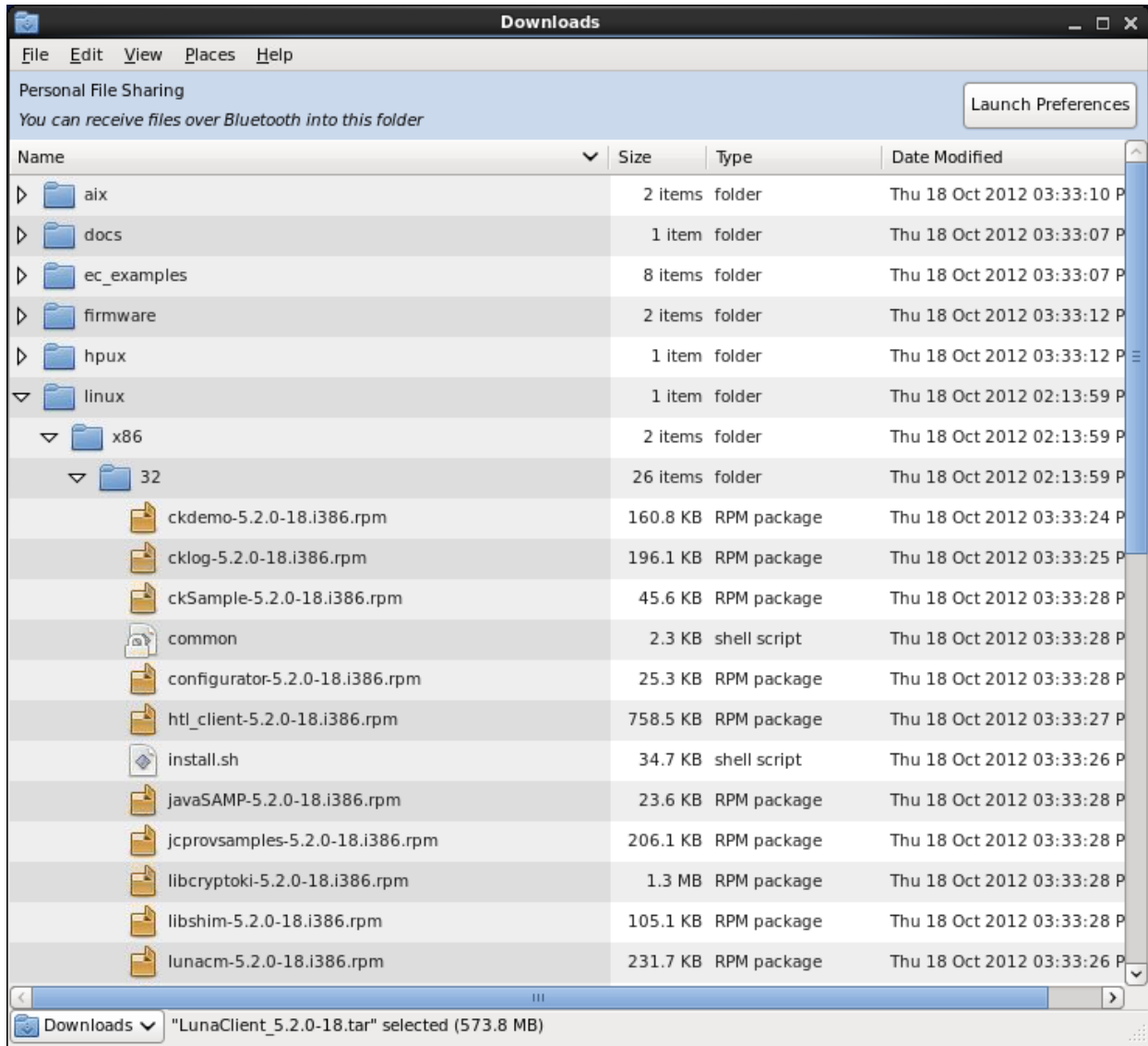

9. To see the help, or a list of available installer options, type:

```
./sh install.sh -? or ./sh install.sh --help
```

To install all available products and optional components, type:

```
./sh install.sh all
```

To selectively install individual products and optional components, type the command without arguments:

```
./sh install.sh
```

10. Type **y** if you agree to be bound by the license agreement.
11. A list of installable SafeNet products appears (might be different, depending on your platform). Select as many as you require, by typing the number of each (in any order) and pressing [Enter]. As each item is selected, the list updates, with a "*" in front of any item that has been selected. This example shows items 1 and 3 have been selected, and item 4 is about to be selected.

```

Products
Choose Luna Products to be installed
  * [1]: SafeNet Network HSM
    [2]: SafeNet PCIe HSM
  * [3]: SafeNet USB HSM
    [4]: SafeNet Remote Backup HSM
  [N|n]: Next
  [Q|q]: Quit
Enter selection: 4

```

12. When selection is complete, type "N" or "n" for "Next", and press [Enter]. If you wish to make a change, simply type a number again and press [Enter] to de-select a single item.
13. The next list is called "Advanced" and includes additional items to install. Some items might be pre-selected to provide the optimum SafeNet HSM experience for the majority of customers, but you can change any selection in the list. When the Components list is adjusted to your satisfaction, press [Enter].



Note: The installer includes the SafeNet SNMP Subagent as an option. If you select this option, you will need to move the SafeNet MIB files to the appropriate directory for your SNMP application after installation is complete, and you will need to start the SafeNet subagent and configure for use with your agent. See the *Administration Guide* for more information.

14. If the script detects an existing cryptoki library, it stops and suggests that you uninstall your previous SafeNet software before starting the SafeNet Client installation again.
15. The system installs all packages related to the products and any optional components that you selected.

As a general rule, do not modify the `Chrystoki.conf/crystoki.ini` file, unless directed to do so by SafeNet Customer Support. If you do modify the file, never insert TAB characters - use individual space characters. Avoid modifying the PED timeout settings. These are now hardcoded in the appliance, but the numbers in the `Chrystoki.conf` file must match.

Uninstalling the SafeNet HSM Client Software

```
cd /usr/safenet/lunaclient/bin
```

```
./sh uninstall.sh
```

Java

During the installation, the script provides the opportunity to install SafeNet Java components. If you select Java components, the SafeNet Java files are installed below `/usr/safenet/lunaclient/jsp/`. In order to use Java, you must have separately installed Java (JDK or run-time environment from the vendor of your choice) onto your system.

Copy the SafeNet Java library and jar files from their default location under `/usr/safenet/lunaclient/jsp/lib` to the Java environment directory, for example `/usr/jre/lib/ext`.

The exact directory might differ depending on where you obtained your Java system, the version, and any choices that you made while installing and configuring it.

For additional Java-related information, see "[Java Interfaces](#)" on page 1 in the *SDK Reference Guide*.

JSP Static Registration

You would choose static registration of providers if you want all applications to default to our (SafeNet) provider.

Once your client has externally logged in using salogin (see) in the Reference section of this document) or your own HSM-aware utility, any application would be able to use SafeNet product without being designed to login to the HSM Partition.

Edit the `java.security` file located in the `\jre\lib\security` directory of your Java SDK/JRE 7 or 8 installation to read as follows:

```
security.provider.1=sun.security.provider.Sun
security.provider.2=com.sun.net.ssl.internal.ssl.Provider
security.provider.3=com.safenetinc.luna.provider.LunaProvider
security.provider.4=com.sun.rsa.jca.Provider
security.provider.5=com.sun.crypto.provider.SunJCE
security.provider.6=sun.security.jgss.SunProvider
```

You can set our provider in first position for efficiency if SafeNet HSM operations are your primary mode. However, if your application needs to perform operations not supported by the `LunaProvider` (secure random generation or random publickey verification, for example) then it would receive error messages from the HSM and would need to handle those gracefully before resorting to providers further down the list. We have found that having our provider in third position works well for most applications.

The modifications in the "java.security" file are global, and they might result in the breaking of another application that uses the default `KeyPairGenerator` without logging into the SafeNet Network HSM first. This consideration might argue for using dynamic registration, instead.

JSP Dynamic Registration

For your situation, you may prefer to employ dynamic registration of Providers, in order to avoid possible negative impacts on other applications running on the same machine. As well, the use of dynamic registration allows you to keep installation as straightforward as possible for your customers.

Compatibility

We formally test SafeNet HSMs and our Java provider with SUN JDK for all platforms except AIX, and with IBM JDK for the AIX platform. We have not had problems with OpenJDK, although it has not been part of our formal test suite. The SafeNet JCE provider is compliant with the JCE specification, and should work with any JVM that implements the Java language specification.

Occasional problems have been encountered with respect to IBM JSSE.

GNU JDK shipped with most Linux systems has historically been incomplete and not suitable.

Removing Components

To uninstall the JSP component or the SDK component, you must uninstall SafeNet Client completely, then re-run the installation script without selecting the unwanted component(s).

```
sh uninstall.sh
```

[Ctrl] [C] - If you interrupt the installation

Do not interrupt the installation script in progress, and ensure that your host computer is served by an uninterruptible power supply (UPS). If you press [Ctrl] [C], or otherwise interrupt the installation (OS problem, power outage, other), some components will not be installed. It is not possible to resume an interrupted install process. The result of an interruption depends on where, in the process, the interruption occurred (what remained to install before the process was stopped).

As long as the cryptoki RPM package is installed, any subsequent installation attempt results in refusal with the message "A version of SafeNet Client is already installed."

If components are missing or are not working properly after an interrupted installation, or if you wish to install any additional components at a later date (following an interrupted installation, as described), you would need to uninstall everything first. If 'sh uninstall.sh' is unable to do it, then you must uninstall all packages manually.

Because interruption of the install.sh script is not recommended, and mitigation is possible, this is considered a low-likelihood corner case, fully addressed by these comments.

Scripted or Unattended Installation

If you prefer to run the installation from a script, rather than interactively, run the command with the options `-p <list of SafeNet products>` and `-c <list of SafeNet components>`. To see the syntax, run the command with `--help` like this:

```
[myhost]$ sh ../Luna Client_5.3.0-5x/linux/64/install.sh --help
Installing from ../Luna Client_5.3.0-x/linux/64
```

At least one product should be specified.

usage:

```
install.sh      - Luna Client install through menu
install.sh help - Display scriptable install options
install.sh all  - Complete Luna Client install
```

```
install.sh -p [sa|pci|g5|rb] [-c sdk|jsp|jcprov|ldpc|snmp]
```

```
-p <list of Luna products>
```

```
-c <list of Luna components> - Optional. All components are installed if not provided
```

Luna products options

```
sa      - SafeNet Network HSM
pci     - SafeNet PCIe HSM
g5      - SafeNet USB HSM
rb      - SafeNet Remote Backup HSM
```

Luna components options

```
sdk     - Luna SDK
jsp     - Luna JSP (Java)
jcprov  - Luna JC PROV (Java)
snmp    - Luna SNMP subagent
```

```
[myhost]$
```

For scripted/automated installation, your script will need to capture and respond to the License Agreement prompt, and to the confirmation prompt. For example:

```
[myhost]$ ./install.sh all
Installing from /home/me/Downloads/Luna Client_5.3.0/linux/64
```

```
IMPORTANT: The terms and conditions of use outlined in the software
license agreement (Document #008-010005-001_053110) shipped with the product
("License") constitute a legal agreement between you and SafeNet Inc.
Please read the License contained in the packaging of this
product in its entirety before installing this product.
```

Do you agree to the License contained in the product packaging?

If you select 'yes' or 'y' you agree to be bound by all the terms and conditions set out in the License.

If you select 'no' or 'n', this product will not be installed.

(y/n) **y**

Complete Luna Client will be installed. This includes SafeNet Network HSM, SafeNet PCIe HSM, SafeNet USB HSM AND SafeNet Remote Backup HSM.

Select 'yes' or 'y' to proceed with the install.

Select 'no' or 'n', to cancel this install.

Continue (y/n)? **y**

SUSE Linux on IBM PPC

JCE un-restriction files must be downloaded from IBM, not from SUN, for this platform. Attempting to use SUN JCE un-restriction files on IBM PowerPC systems with SUSE Linux causes signing errors with Java 5 and Java 6.

32-bit Client on 64-bit RedHat 6

While no errors normally appear when installing 64-bit client on 64-bit RedHat 6, some preparation is required to avoid installation errors when installing 32-bit Client on 64-bit OS. Do the following:

- yum install glibc.i686
- yum upgrade libstdc++
- yum install libstdc++.i686
- yum install libgcc.i686

Then run the 32-bit installer

./install.sh

Failure to perform those steps before launching the installer can result in output like the following:

```
Installing the Luna Client 5.3.0-5...
Adding new version of configurator
/home/builds/Luna Client/CLT_SDK/5.3.0/Luna Client_5.3.0-5/Luna Client_5.3.0-5/linux/32
Preparing... ##### [100%]
1:configurator ##### [100%]
Adding new version of libcryptoki
/home/builds/Luna Client/CLT_SDK/5.3.0/Luna Client_5.3.0-5/Luna Client_5.3.0-5/linux/32
Preparing... ##### [100%]
1:libcryptoki ##### [100%]
Checking for /etc/Chrystoki.conf.rpmsave
Using new /etc/Chrystoki.conf
/var/tmp/rpm-tmp.ndfBQQ: /usr/safenet/lunaclient/bin/configurator: /lib/ld-linux.so.2: bad ELF
interpreter: No such file or directory
/var/tmp/rpm-tmp.ndfBQQ: /usr/safenet/lunaclient/bin/configurator: /lib/ld-linux.so.2: bad ELF
interpreter: No such file or directory
/var/tmp/rpm-tmp.ndfBQQ: /usr/safenet/lunaclient/bin/configurator: /lib/ld-linux.so.2: bad ELF
interpreter: No such file or directory
```

```

/var/tmp/rpm-tmp.ndfBQQ: /usr/safenet/lunaclient/bin/configurator: /lib/ld-linux.so.2: bad ELF
interpreter: No such file or directory
/var/tmp/rpm-tmp.ndfBQQ: /usr/safenet/lunaclient/bin/configurator: /lib/ld-linux.so.2: bad ELF
interpreter: No such file or directory
/var/tmp/rpm-tmp.ndfBQQ: /usr/safenet/lunaclient/bin/configurator: /lib/ld-linux.so.2: bad ELF
interpreter: No such file or directory
/var/tmp/rpm-tmp.ndfBQQ: /usr/safenet/lunaclient/bin/configurator: /lib/ld-linux.so.2: bad ELF
interpreter: No such file or directory
/var/tmp/rpm-tmp.ndfBQQ: /usr/safenet/lunaclient/bin/configurator: /lib/ld-linux.so.2: bad ELF
interpreter: No such file or directory
/var/tmp/rpm-tmp.ndfBQQ: /usr/safenet/lunaclient/bin/configurator: /lib/ld-linux.so.2: bad ELF
interpreter: No such file or directory
/var/tmp/rpm-tmp.ndfBQQ: /usr/safenet/lunaclient/bin/configurator: /lib/ld-linux.so.2: bad ELF
interpreter: No such file or directory
/var/tmp/rpm-tmp.ndfBQQ: /usr/safenet/lunaclient/bin/configurator: /lib/ld-linux.so.2: bad ELF
interpreter: No such file or directory
Adding new version of libshim
/home/builds/Luna Client/CLT_SDK/5.3.0/Luna Client_5.3.0-5/Luna Client_5.3.0-5/linux/32
Preparing... ##### [100%]
1:libshim ##### [100%]
Adding new version of lunacm
/home/builds/Luna Client/CLT_SDK/5.3.0/Luna Client_5.3.0-5/Luna Client_5.3.0-5/linux/32
Preparing... ##### [100%]
1:lunacm ##### [100%]
Adding new version of lunacmu
/home/builds/Luna Client/CLT_SDK/5.3.0/Luna Client_5.3.0-5/Luna Client_5.3.0-5/linux/32
Preparing... ##### [100%]
1:lunacmu ##### [100%]
Adding new version of ckdemo
/home/builds/Luna Client/CLT_SDK/5.3.0/Luna Client_5.3.0-5/Luna Client_5.3.0-5/linux/32
Preparing... ##### [100%]
1:ckdemo ##### [100%]
Adding new version of multitoken
/home/builds/Luna Client/CLT_SDK/5.3.0/Luna Client_5.3.0-5/Luna Client_5.3.0-5/linux/32
Preparing... ##### [100%]
1:multitoken ##### [100%]
Adding new version of cklog
/home/builds/Luna Client/CLT_SDK/5.3.0/Luna Client_5.3.0-5/Luna Client_5.3.0-5/linux/32
Preparing... ##### [100%]
1:cklog ##### [100%]
Adding new version of salogin
/home/builds/Luna Client/CLT_SDK/5.3.0/Luna Client_5.3.0-5/Luna Client_5.3.0-5/linux/32
Preparing... ##### [100%]
1:salogin ##### [100%]
Adding new version of vtl
/home/builds/Luna Client/CLT_SDK/5.3.0/Luna Client_5.3.0-5/Luna Client_5.3.0-5/linux/32
Preparing... ##### [100%]
1:vtl ##### [100%]
Adding new version of htl_client
/home/builds/Luna Client/CLT_SDK/5.3.0/Luna Client_5.3.0-5/Luna Client_5.3.0-5/linux/32
Preparing... ##### [100%]
1:htl_client ##### [100%]
/var/tmp/rpm-tmp.bLgG1F: /usr/safenet/lunaclient/bin/configurator: /lib/ld-linux.so.2: bad ELF
interpreter: No such file or directory
Starting htl_client:/etc/init.d/htlc_service: /usr/safenet/lunaclient/htl/htl_client: /lib/ld-

```

```
linux.so.2: bad ELF interpreter: No such file or directory
FAILED
warning: %post(htl_client-5.3.0-5.i386) scriptlet failed, exit status 1
Adding new version of javaSAMP
/home/builds/Luna Client/CLT_SDK/5.3.0/Luna Client_5.3.0-5/Luna Client_5.3.0-5/linux/32
Preparing... ##### [100%]
1:javaSAMP ##### [100%]
Adding new version of ckSample
/home/builds/Luna Client/CLT_SDK/5.3.0/Luna Client_5.3.0-5/Luna Client_5.3.0-5/linux/32
Preparing... ##### [100%]
1:ckSample ##### [100%]
```

If the installation script proceeds to the end, with the above errors, the installation appears successful, but you are unable to create certs. Re-do.

After Installation

When you have installed the software onto a Client, the next task is to configure the SafeNet HSM, as described in the *Configuration Guide*.

Solaris SafeNet HSM Client Installation

These instructions assume that you have already acquired the SafeNet HSM client software in the form of a downloaded .tar archive.

Applicability to specific versions of Solaris is summarized in the Customer Release Notes for the current release.



Note: Before installing a SafeNet system, you should confirm that the product you have received is in factory condition and has not been tampered with in transit. Refer to the Startup Guide included with your product shipment. If you have any questions about the condition of the product that you have received, contact Gemalto Support.

Each computer that connects to the SafeNet HSM appliance as a client must have the cryptoki library, the vtl client shell and other utilities and supporting files installed.

Each computer that contains, or is connected to a SafeNet USB HSM or a SafeNet PCIe HSM must have the cryptoki library and other utilities and supporting files installed.



Note: This example shows all the SafeNet HSM client products and components. Some items are not supported on all operating systems and therefore do not appear as you proceed through the installation script.

Prerequisites

Before starting the installation, ensure that you have satisfied the following prerequisites:

Random Number Generator (RNG) or Entropy Gathering Daemon (EGD)

Ensure that you have a Random Number Generator (RNG) or Entropy Gathering Daemon (EGD) on your system in one of the following locations:

- /dev/egd-pool
- /etc/egd-pool,
- /etc/entropy
- /var/run/egd-pool

RNG/EGD

Cryptographic algorithms, including those that assure the security of communication – such as in OpenSSL and other protocols – depend upon random numbers for the creation of strong keys and certificates. A readily available source of random data is the entropy that exists in complex computer processes. Utilities exist for every operating system, to gather bits of system entropy into a pool, which can then be used by other processes.

Windows and Linux have these installed by default. Other systems may or may not. See your system administrator.

You Need an Entropy Pool

In the case of SafeNet Network HSM, the SafeNet Client administration tool (**vtl**) expects to find a source of randomness at **/dev/random**. If one is not found, **vtl** fails, because the link cannot be secured from the Client end.

If your system does have an entropy pool, but the random number generator (RNG) is not in the expected place, then you can create a symbolic link between the actual location and one of the following:

- /dev/random
- /dev/egd-pool
- /etc/egd-pool
- /etc/entropy
- /var/run/egd-pool

If your system does not have an entropy gathering daemon or random number generator, please direct your system administrator to install one, and point it to one of the named devices.

Installing the Client Software

It is recommended that you refer to the SafeNet HSM Customer Release Notes for any installation-related issues or instructions before you begin the following software installation process.



CAUTION: You must be logged in as **root** when you run the installation script.

By default, the Client programs are installed in the **/opt/safenet/lunaclient/bin** directory.

To install the SafeNet HSM client software on a Solaris workstation

1. Log on to the client system, open a console or terminal window, and use **su** to gain administrative permissions for the installation.
2. Access the SafeNet HSM client software:

DVD	<ol style="list-style-type: none"> 1. Insert the DVD (mount it if you do not have automount). 2. Go to the DVD (/cdrom or whatever device name your system uses)
Tar archive	<ol style="list-style-type: none"> 1. Copy or move the .tar archive to a suitable directory where you can untar the archive and launch the installation script. 2. Extract the contents from the archive: tar xvf <filename>.tar

3. Go to the install directory for your architecture:

Architecture	Path
Solaris Sparc 32-bit	<dvd_or_tarball_path>/solaris/sparc/32
Solaris Sparc 64-bit	<dvd_or_tarball_path>/solaris/sparc/64
Solaris x86 32-bit	<dvd_or_tarball_path>/solaris/x86/32
Solaris x86 64-bit	<dvd_or_tarball_path>/solaris/x86/64



Note: Not all platforms are supported with each release, so the available install options might not match the list above. Refer to the Customer Release Notes for more information.

4. To see the help, or a list of available installer options, type:

sh install.sh -? or **sh install.sh --help**

To install all available products and optional components, type:

```
sh install.sh all
```

To selectively install individual products and optional components, type the command without arguments:

```
sh install.sh
```

5. Type **y** if you agree to be bound by the license agreement.
6. A list of installable SafeNet products is displayed (might be different, depending on your platform). Select as many as you require, by typing the number of each (in any order) and pressing [Enter]. As each item is selected, the list updates, with a "*" in front of any item that has been selected. The following example shows that items 1 and 3 have been selected, and item 4 is about to be selected.

```
Products
Choose Luna Products to be installed
*[1]: SafeNet Network HSM
 [2]: SafeNet PCIe HSM
*[3]: SafeNet USB HSM
 [4]: SafeNet Remote Backup HSM
[N|n]: Next
[Q|q]: Quit
Enter selection: 4
```

7. When the selection is complete, type "N" or "n" for "Next", and press [Enter]. If you wish to make a change, simply type a number again and press [Enter] to de-select a single item.
8. The next list is called "Advanced" and includes additional items to install. Some items might be pre-selected to provide the optimum SafeNet HSM experience for the majority of customers, but you can change any selection in the list. When the Components list is adjusted to your satisfaction, press [Enter].



Note: The installer includes the SafeNet SNMP Subagent as an option. If you select this option, you will need to move the SafeNet MIB files to the appropriate directory for your SNMP application after installation is complete, and you will need to start the SafeNet subagent and configure for use with your agent. See the *Administration Guide* for more information.

9. If the script detects an existing cryptoki library, it stops and suggests that you uninstall your previous SafeNet software before starting the SafeNet Luna Client installation again.
10. The system installs all packages related to the products and any optional components that you selected.

As a general rule, do not modify the `Chrystoki.conf/crystoki.ini` file, unless directed to do so by SafeNet Customer Support. If you do modify the file, never insert TAB characters - use individual space characters. Avoid modifying the PED timeout settings. These are now hardcoded in the appliance, but the numbers in the `Chrystoki.conf` file must match.

Uninstalling the SafeNet Luna HSM Client Software

```
cd /opt/safenet/lunaclient/bin
```

```
sh uninstall.sh
```

Java

During the installation, the script provides the opportunity to install SafeNet Java components. If you select Java components, the SafeNet Java files are installed below `/opt/safenet/lunaclient/jsp/`. In order to use Java, you must have separately installed Java (JDK or run-time environment from the vendor of your choice) onto your system.

Copy the SafeNet Java library and jar files from their default location under `/opt/safenet/lunaclient/jsp/lib` to the Java environment directory, for example `/opt/jre/lib/ext`.

The exact directory might differ depending on where you obtained your Java system, the version, and any choices that you made while installing and configuring it.

For additional Java-related information, see "Java Interfaces" on page 1 in the *SDK Reference Guide*.

JSP Static Registration

You would choose static registration of providers if you want all applications to default to our (SafeNet) provider.

Once your client has externally logged in using `salogin` (see) in the Reference section of this document) or your own HSM-aware utility, any application would be able to use SafeNet product without being designed to login to the HSM Partition.

Edit the `java.security` file located in the `\jre\lib\security` directory of your Java SDK/JRE 7 or 8 installation to read as follows:

```
security.provider.1=sun.security.provider.Sun
security.provider.2=com.sun.net.ssl.internal.ssl.Provider
security.provider.3=com.safenetinc.luna.provider.LunaProvider
security.provider.4=com.sun.rsajca.Provider
security.provider.5=com.sun.crypto.provider.SunJCE
security.provider.6=sun.security.jgss.SunProvider
```

You can set our provider in first position for efficiency if SafeNet HSM operations are your primary mode. However, if your application needs to perform operations not supported by the `LunaProvider` (secure random generation or random publickey verification, for example) then it would receive error messages from the HSM and would need to handle those gracefully before resorting to providers further down the list. We have found that having our provider in third position works well for most applications.

The modifications in the "java.security" file are global, and they might result in the breaking of another application that uses the default `KeyPairGenerator` without logging into the SafeNet Network HSM first. This consideration might argue for using dynamic registration, instead.

JSP Dynamic Registration

For your situation, you may prefer to employ dynamic registration of Providers, in order to avoid possible negative impacts on other applications running on the same machine. As well, the use of dynamic registration allows you to keep installation as straightforward as possible for your customers.

Compatibility

We formally test SafeNet HSMs and our Java provider with SUN JDK for all platforms except AIX, and with IBM JDK for the AIX platform. We have not had problems with OpenJDK, although it has not been part of our formal test suite. The SafeNet JCE provider is compliant with the JCE specification, and should work with any JVM that implements the Java language specification.

Occasional problems have been encountered with respect to IBM JSSE.

GNU JDK shipped with most Linux systems has historically been incomplete and not suitable.

Removing Components

To uninstall the JSP component or the SDK component, you must uninstall SafeNet Luna Client completely, then re-run the installation script without selecting the unwanted component(s).

```
sh uninstall.sh
```

[Ctrl] [C] - If you interrupt the installation

Do not interrupt the installation script in progress, and ensure that your host computer is served by an uninterruptible power supply (UPS). If you press [Ctrl] [C], or otherwise interrupt the installation (OS problem, power outage, other), some components will not be installed. It is not possible to resume an interrupted install process. The result of an interruption depends on where, in the process, the interruption occurred (what remained to install before the process was stopped).

As long as the cryptoki RPM package is installed, any subsequent installation attempt results in refusal with the message "A version of Luna Client is already installed."

If components are missing or are not working properly after an interrupted installation, or if you wish to install any additional components at a later date (following an interrupted installation, as described), you would need to uninstall everything first. If 'sh uninstall.sh' is unable to do it, then you must uninstall all packages manually.

Because interruption of the install.sh script is not recommended, and mitigation is possible, this is considered a low-likelihood corner case, fully addressed by these comments.

After Installation

When you have installed the software onto a Client, the next task is to configure the SafeNet HSM, as described in the *Configuration Guide*.

Windows SafeNet HSM Client Installation

Applicability to specific versions of Windows is summarized in the Customer Release Notes for this release.



Note: Before installing a SafeNet HSM system, you should confirm that the product you have received is in factory condition and has not been tampered with in transit. Refer to the Startup Guide included with your product shipment. If you have any questions about the condition of the product that you have received, please contact SafeNet Support immediately.

Required Client Software

Each computer that connects to the SafeNet Network HSM as a Client must have the cryptoki library, the vtl client shell and other utilities and supporting files installed.

Each computer that contains, or is connected to a SafeNet PCIe HSM or a SafeNet USB HSM must have the cryptoki library and other utilities and supporting files installed.

Windows Server Prerequisites

Before installing SafeNet Client on Windows Server 2012/2012R2, you must satisfy the following prerequisites:

- **Install .NET framework version 3.5:** Other versions of .NET can be installed on your system simultaneously without conflict, but version 3.5 is required for SafeNet Client to launch HTL. For more information, see "[Windows Server 2012 SafeNet HSM Client Supplemental Configuration](#)" on page 97.
- **Install the Universal C Runtime and its prerequisites:** The SafeNet Client installer requires the Microsoft Universal C Runtime (Universal CRT) to run properly. Universal CRT requires your Windows machine to be up to date. Before running the SafeNet Client installer, ensure that you have the Universal C Runtime in Windows (KB2999226) update and its prerequisites installed on your machine. The following updates must be installed in order:
 - a. March 2014 Windows servicing stack update (See <https://support.microsoft.com/en-us/help/2919442>)
 - b. April 2014 Windows update (See <https://support.microsoft.com/en-us/help/2919355>)
 - c. Universal C Runtime update (See <https://support.microsoft.com/en-us/kb/2999226>)

Before Installing SafeNet Client on Windows Server 2008 R2:

- See **Microsoft Security Advisory 3033929** Availability of SHA-2 Code Signing Support for Windows 7 and Windows Server 2008 R2 <https://technet.microsoft.com/en-us/library/security/3033929> and install the appropriate Windows update. This allows Windows 2008 R2 to recognize driver software signed with certificates based on the more secure SHA-256 mechanism. Without the update, the HSM drivers are prevented from working and any installed SafeNet HSMs are not visible as slots.

Installing the SafeNet HSM Client Software

The supported Windows servers are 64-bit. They allow running of 32-bit or 64-bit applications.

For compatibility of our HSMs with Windows in general, we provide both 32-bit and 64-bit libraries for use with your applications as appropriate, but our supplied tools (lunacm, cmu, multitoken, etc.) are 64-bit versions only. This is because 64-bit tools are all that is needed on a 64-bit OS, but we mention it in case you were looking for 32-bit equivalents - there aren't any because none are needed.

For compatibility of our HSMs with Windows CAPI we have SafeNet CSP, and for the newer Windows CNG we have SafeNet KSP. If you are using either, then a section near the end of this chapter has additional specific instructions.

Interactive (prompted) and non-interactive (no prompts) installation options are available.

To install the SafeNet HSM client software

1. Log into Windows as “Administrator”, or as a user with administrator privileges (see Troubleshooting tips, below).
2. Insert the SafeNet Client Software DVD into your optical drive.
3. Click **Start > Run** and then type:

d:\windows\64\LunaClient.exe

where “d” is your CDROM drive

or use Explorer to navigate the CD directories and double click the appropriate **LunaClient.exe**.



Note: The installer is 64-bit only. If you have 32-bit applications, proceed with the 64-bit installation, then see ["Using 32-bit Applications With the SafeNet Client" on page 91](#).

4. At the Welcome screen, click **Next**.

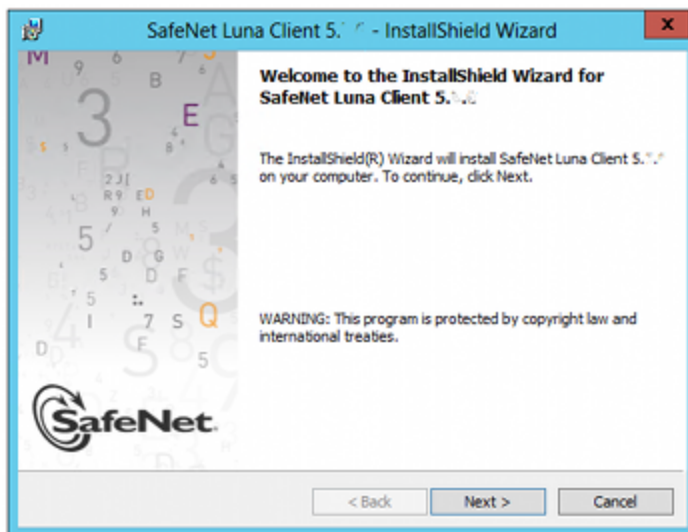

5. Accept the software license agreement.

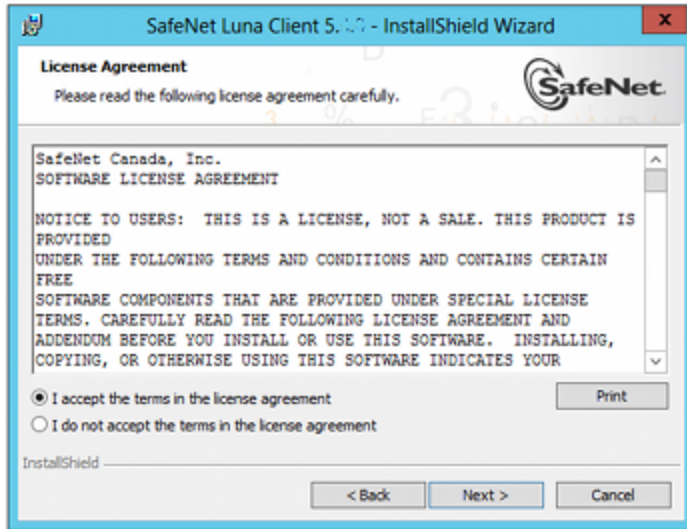

6. In the **Choose Destination Location** dialog, accept the default that is offered, or make a change if you prefer.

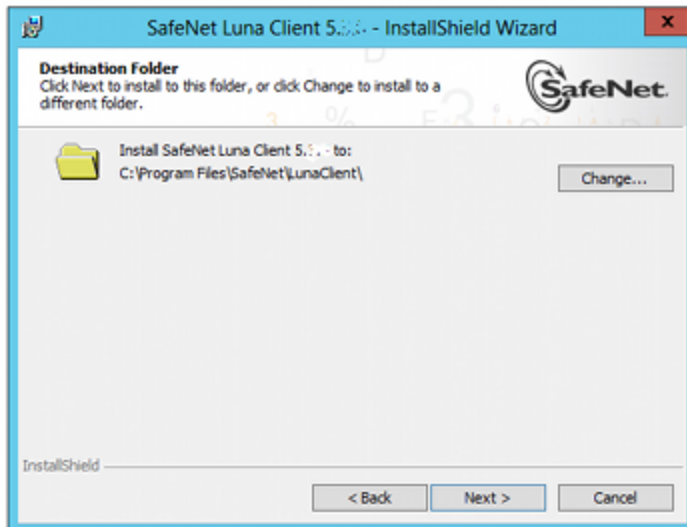

7. Click to select any of the SafeNet Product software options that you wish to install. Any that are marked with a red "X" are currently de-selected and will not be installed when you proceed. You must accept at least the major feature for your HSM. You can select all, if you wish - there is no conflict.

The installer includes the SafeNet SNMP Subagent as an option with any of the SafeNet HSMs, except SafeNet Network HSM (which has agent and subagent built in). For any of SafeNet PCIe HSM, SafeNet USB HSM, or SafeNet Backup HSMs, include the subagent with any of the products, if desired - it doesn't matter which; it's the same subagent, and it goes to the same location on your hard disk.

After installation is complete, you will need to move the SafeNet MIB files to the appropriate directory for your SNMP application, and you will need to start the SafeNet subagent and configure for use with your agent, as described in the *Administration Guide*.

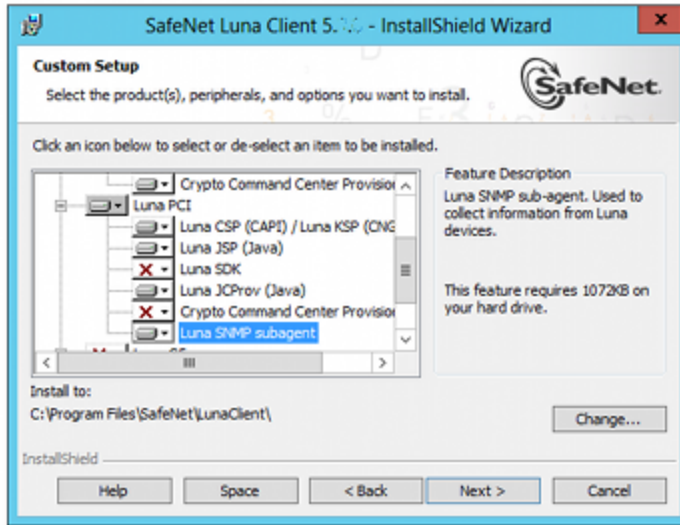

8. On the **Ready to Install** page click **Install**.

If you wish to modify any of your previous selections, you can still click **Back** to see previous pages. Once you click **Install**, you are committed to the installation.

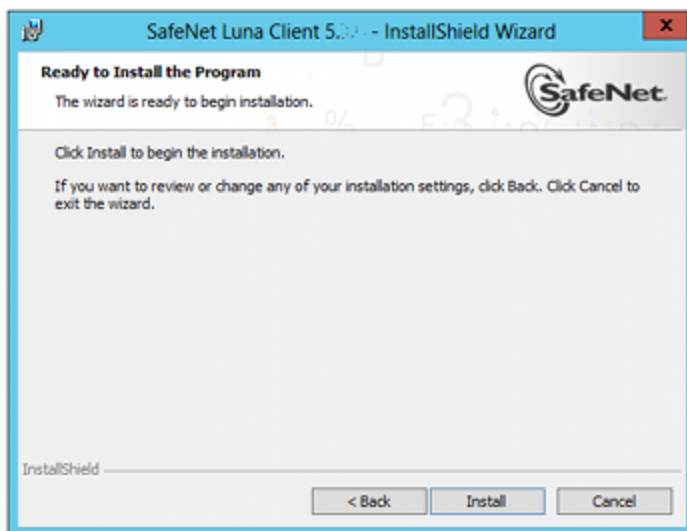

9. If Windows presents a security notice asking if you wish to install the device driver from SafeNet, click **Install** to accept.





Note: If you choose not to install the driver, your SafeNet Client cannot function with any locally connected SafeNet hardware (which includes SafeNet PCIe HSM, SafeNet USB HSM, or SafeNet Remote Backup HSMs).

10. When the installation completes, click **Finish**.

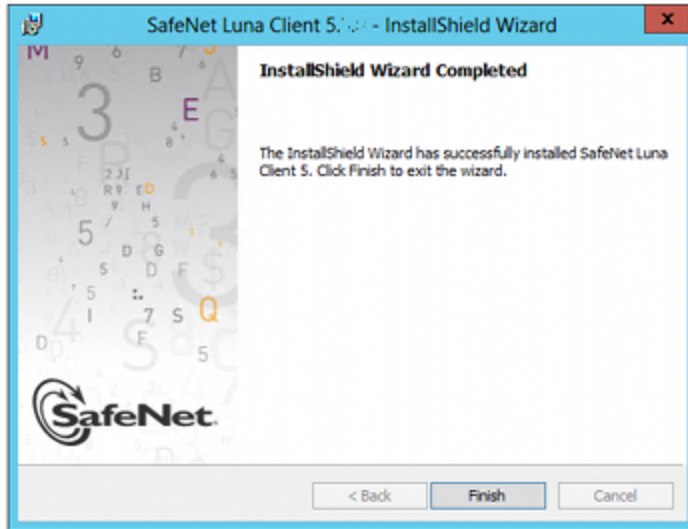

11. Ensure that **every** copy of PuTTY that you have on **any** Windows host, that connects via SSH to the SafeNet Network HSM, is replaced by the version of PuTTY that accompanies the new client software.



Note: Use of older PuTTY versions, and related tools, can result in the appliance refusing to accept a connection. This can happen if a security update imposes restrictions on connections with older versions. To ensure compatibility, always use the versions of executable files included with the current client installer.

As a general rule, do not modify the `Chrystoki.conf/crystoki.ini` file, unless directed to do so by SafeNet Customer Support. If you do modify the file, never insert TAB characters - use individual space characters. Avoid modifying the PED timeout settings. These are now hardcoded in the appliance, but the numbers in the `Chrystoki.conf` file must match.

12. After the client software installation finishes, **reboot the client computer**.

Scripted or unattended installation of the SafeNet Client

If desired, you can script the installation. Each Linux or UNIX version has its own method for unattended installations. Windows allows you to add flags following the `LunaClient.exe` command.

For more detailed information, see ["Scripted / Unattended Installation on Windows" on page 101](#).

Java

During the installation, if you allow our Java Security Provider to be installed, the SafeNet Java files are installed below **C:\Program Files\Luna Client\JSP\lib**. In order to use our JSP, you must have separately installed Java (JDK or run-time environment from the vendor of your choice) onto your system.

Copy the SafeNet Java files from their default location under **C:\Program Files\SafeNet\Luna Client\JSP\lib** to the Java environment directory, for example **C:\Program Files\Java\jre6\lib\ext**.



Note: The exact directory might differ depending on where you obtained your Java system, the version, and any choices that you made while installing and configuring it.

Using a 32-bit JDK on a 64-bit OS

If you install a 32-bit JDK on a 64-bit OS, you must copy the **LunaAPI.dll** file to **C:\Windows\SysWOW64** (instead of **C:\Windows\System32**)

Java 7 and Java 8 Library Path Issue

SafeNet has traditionally recommended that you put **LunaAPI.dll** in the `<java install dir>/lib/ext` folder.

However, Java 7 and Java 8 for Windows have removed that directory from the Java library path. As a result, when a Java 7 or Java 8 application on Windows uses the SafeNet provider, it cannot find the **LunaAPI.dll** library, causing the application to fail.

To address this problem, we suggest that you use one of the following methods to add **LunaAPI.dll** to the Java 7 or Java 8 search path:

- Put **LunaAPI.dll** in an arbitrary folder and add that folder to the system path. Java 7 or Java 8 will search the system path for **LunaAPI.dll**.

OR

- Put **LunaAPI.dll** in the Windows system folder: **C:\Windows\System32**
Use that destination for both 32-bit and 64-bit

Alternatively, at the command line, specify: `"%JAVA_HOME%\jre\bin/java" -Djava.library.path="C:\path\to\lunaapi.dll" -jar jMultitoken.jar`

For additional Java-related information, see ["Java Interfaces"](#) on page 1 in the *SDK Reference Guide*.

JSP Static Registration

You would choose static registration of providers if you want all applications to default to our (SafeNet) provider.

Once your client has externally logged in using `salogin` (see) in the Reference section of this document) or your own HSM-aware utility, any application would be able to use SafeNet product without being designed to login to the HSM Partition.

Edit the `java.security` file located in the `\jre\lib\security` directory of your Java SDK/JRE 7 or 8 installation to read as follows:

```
security.provider.1=sun.security.provider.Sun
security.provider.2=com.sun.net.ssl.internal.ssl.Provider
security.provider.3=com.safenetinc.luna.provider.LunaProvider
security.provider.4=com.sun.rsajca.Provider
security.provider.5=com.sun.crypto.provider.SunJCE
```

```
security.provider.6=sun.security.jgss.SunProvider
```

You can set our provider in first position for efficiency if SafeNet HSM operations are your primary mode. However, if your application needs to perform operations not supported by the LunaProvider (secure random generation or random publickey verification, for example) then it would receive error messages from the HSM and would need to handle those gracefully before resorting to providers further down the list. We have found that having our provider in third position works well for most applications.

The modifications in the "java.security" file are global, and they might result in the breaking of another application that uses the default KeyPairGenerator without logging into the SafeNet Network HSM first. This consideration might argue for using dynamic registration, instead.

JSP Dynamic Registration

For your situation, you may prefer to employ dynamic registration of Providers, in order to avoid possible negative impacts on other applications running on the same machine. As well, the use of dynamic registration allows you to keep installation as straightforward as possible for your customers.

Compatibility

We formally test SafeNet HSMs and our Java provider with SUN JDK for all platforms except AIX, and with IBM JDK for the AIX platform. We have not had problems with OpenJDK, although it has not been part of our formal test suite. The SafeNet JCE provider is compliant with the JCE specification, and should work with any JVM that implements the Java language specification.

Occasional problems have been encountered with respect to IBM JSSE.

GNU JDK shipped with most Linux systems has historically been incomplete and not suitable.

CSP and KSP

SafeNet CSP allows you to use the SafeNet HSM with Microsoft CAPI, which is supported on 32-bit and on 64-bit Windows.

SafeNet KSP allows you to use the SafeNet HSM with Microsoft CNG, which is newer, has additional functions, and supersedes CAPI.

Both of these require modifications to the Windows Registry.

SafeNet CSP

For SafeNet CSP, the utility **register.exe** takes care of the registry.

Just remember to run the 64-bit version, the 32-bit version, or both, depending on the applications you are running.

- Register the csp dll:
register.exe /library
- Register the partition:
register <no arguments>

SafeNet KSP

For SafeNet KSP, the utility **KspConfig.exe** takes care of the registry. Follow instructions for the use of the graphical KspConfig.exe as described in "KSP for CNG" on page 1 in the *SDK Reference Guide*. Just remember to run the 64-bit version, the 32-bit version, or both, depending on the applications you are running.



Note: The **cryptoki.ini** file, which specifies many configuration settings for your HSM and related software, includes a line that specifies the path to the appropriate libNT for use with your application(s). Verify that the path is correct



Note: If SafeNet CSP (CAPI) / SafeNet KSP(CNG) is selected at installation time then the **SafeNetKSP.dll** file is installed in these two locations:

- **C:\Windows\System32** (used for 64-bit KSP)
- **C:\Windows\SysWOW64** (used for 32-bit KSP)

Using 32-bit Applications With the SafeNet Client

Beginning with version 5.2, SafeNet discontinued SafeNet Client support for Windows 32-bit operating systems. We continue to supply 32-bit libraries that can be used on 64-bit Windows OS to support your older 32-bit client applications.

SafeNet Client 32-bit libraries (**cryptoki.dll**, **cklog.dll**, etc.) and versions of CSP and KSP libraries and tools are installed in the **C:\Program Files\SafeNet\Luna Client\win32** directory.

The **win32** directory content is as follows:

- **cklog201.dll**
- **cklog201.dll.sig**
- **cryptoki.dll**
- **cryptoki.dll.sig**
- **shim.dll**
- **shim.dll.sig**
- **jsp** directory which contains:
 - **LunaAPI.dll**

If the SafeNet CSP (CAPI) / SafeNet KSP(CNG) feature is installed, the following are also installed under **win32**:

- **csp** directory which contains:
 - **keymap**
 - **LunaCSP.dll**
 - **LunaCSP.sig**
 - **ms2Luna**
 - **register**
- **KSP** directory that contains:
 - **kspcmd**
 - **KspConfig**
 - **ksputil**
 - **ms2Luna**

In order to properly use the 32-bit library and tools on 64-bit systems there are two basic approaches:

Direct loading of library

Set your application to load the 32-bit library installed under the win32 directory, and run your application. For an example on how to load the cryptoki library dynamically, please refer to the SafeNet SDK.

This should work for any application that directly points to the needed library, and represents the majority of customer applications.

Loading the library via the configuration file

If you require your 32-bit Windows application to run on 64-bit Windows and your application uses the cryptoki.ini to find the location of the cryptoki library (such as applications that use ckbridge - no longer distributed - or that use CSP), we recommend creating a new copy of the cryptoki.ini file under the win32 directory to point to the 32-bit cryptoki library as described below:

- Install SafeNet Client and configure the HSM or SA client as you would normally do.
- Create a copy of the cryptoki.ini file and store it in the win32 directory.
- Modify the LibNT entry in the file (the copy in the win32 directory) to point to the cryptoki.dll library located in the win32 directory
LibNT=C:\Program Files\SafeNet\Luna Client\win32\cryptoki.dll
- Open a new DOS prompt (to be used to run your application).
- Set the ChrystokiConfigurationPath environment variable to point to the win32 directory set
ChrystokiConfigurationPath= C:\Program Files\SafeNet\Luna Client\win32\
- Run your application.

It is very possible to run 64-bit SafeNet tools (such as lunacm, ckdemo, cmu, vtl) in a Command Prompt window, while simultaneously running your 32-bit application in another Command Prompt window (using the 32-bit library by virtue of the ChrystokiConfigurationPath environment variable and the cryptoki.ini file described above), and the two do not conflict, because the environments are independent. Where a problem might arise, however is if your use of the SafeNet tools were to make alterations to the original cryptoki.ini file; we will call it the primary. Your application would be looking to the version of the cryptoki.ini file in C:\Program Files\SafeNet\Luna Client\win32\ which would not contain the changes resulting from the SafeNet tools; we will call that one the secondary. To correct this, you must reproduce any changes from the primary cryptoki.ini to the secondary, before relaunching your 32-bit application.

If a tool causes a change to the configuration file, it will be to the version of the file that exists in the directory where the 64-bit SafeNet tools are located. In order for the change to take effect for your 32-bit application(s), you must update the copy of the configuration file in the location pointed to by the ChrystokiConfigurationPath environment variable, with the new or revised entries.

Examples

When setting up or modifying a network trust link (NTL) connection with a SafeNet Network HSM partition, the **vtl createcert**, **vtl addServer**, **vtl deleteServer**, **vtl replaceServer** commands modify the Crystoki.ini file and make changes to ...certs/server/CAFile.pem. These occur in the folders associated with the 64-bit tools, and must all be replicated to the equivalent .ini file and folders for your 32-bit applications.

If you make any changes using **vtl**, check the file dates on cryptoki.ini and the contents of the certs folders at the main SafeNet HSM Client install location. If any of them have changed compared to the equivalent files at your 32-bit location, make a backup of your 32-bit SafeNet files, and then replace the superseded files in your 32-bit folders with the newer versions from the 64-bit folders.

Running the stc enable or stc disable commands in lunacm will change the cryptoki.ini file. Update the copy that you keep in your 32-bit location to match.

Uninstalling, Modifying, or Repairing the SafeNet Client Software

At any time, you might need to uninstall SafeNet Client, or to modify the installation (perhaps to add a component or product that you did not previously install), or to repair the installed software.

To uninstall, modify, or repair the SafeNet HSM client software

1. Run the **LunaClient.exe** program again. Because the software is already installed on your computer, after you click through the Welcome page, this dialog is displayed:

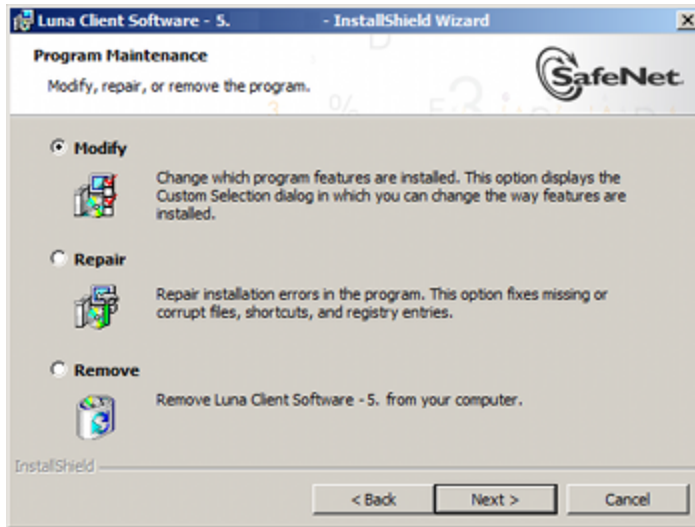

2. Choose the desired option, click **Next**, and follow the prompts. It is possible that you might see a message like this:

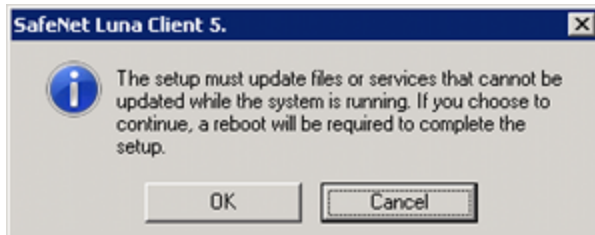

Ignore that message if you see it while uninstalling SafeNet Client. You do not need to restart your computer, and you will not be prompted to do so.

After Installation

When you have installed the software onto a Client, the next task is to configure the SafeNet HSM, as described in the *Configuration Guide*.

Open a new command-line/console window to allow the library path to be found before you run `lunacm` or other utilities that require the library.

Troubleshooting

If you are not the Administrator of the computer on which SafeNet HSM Client is being installed, or if the bundle of permissions in your user profile does not allow you to launch the installer with "Run as Administrator", then some services might not install properly. One option is to have the Administrator perform the installation for you.

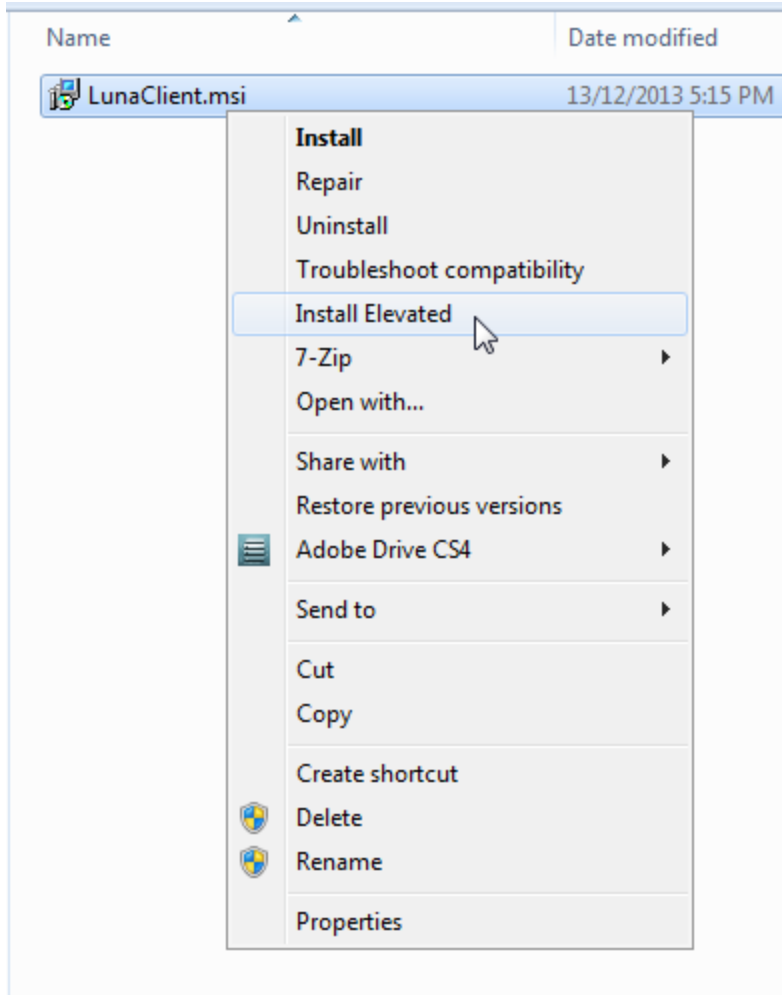

Another approach might be possible. If you have sufficient elevated permissions, you might be able to right-click and open a Command Prompt window as Administrator.

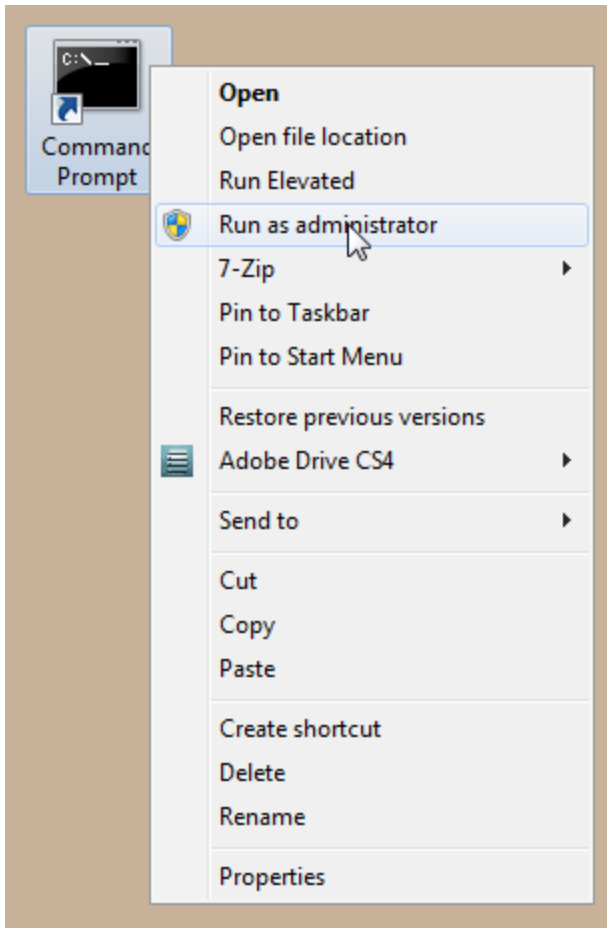

If that option is available, then you can use the command line to move to the location of the LunaClient.msi file and launch it there, which permits the needed services to load for HTL, PedClient, and other SafeNet features.

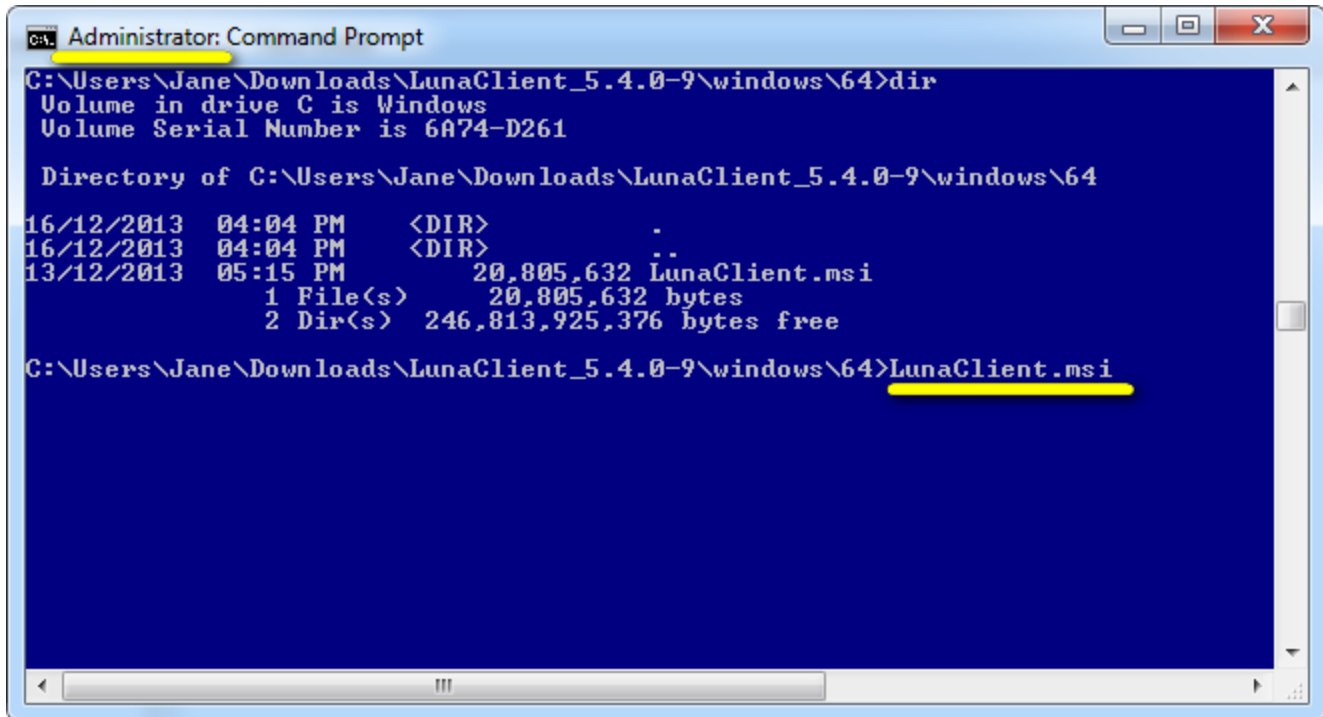

The screenshot shows a Windows Command Prompt window titled "Administrator: Command Prompt". The user is in the directory `C:\Users\Jane\Downloads\LunaClient_5.4.0-9\windows\64`. The command `dir` is executed, showing the following output:

```
C:\Users\Jane\Downloads\LunaClient_5.4.0-9\windows\64>dir
Volume in drive C is Windows
Volume Serial Number is 6A74-D261

Directory of C:\Users\Jane\Downloads\LunaClient_5.4.0-9\windows\64

16/12/2013  04:04 PM    <DIR>          .
16/12/2013  04:04 PM    <DIR>          ..
13/12/2013  05:15 PM           20,805,632  LunaClient.msi
             1 File(s)      20,805,632 bytes
             2 Dir(s)  246,813,925,376 bytes free

C:\Users\Jane\Downloads\LunaClient_5.4.0-9\windows\64>LunaClient.msi
```

The file `LunaClient.msi` is highlighted in yellow in the original image.

Administrator privileges

In Windows 7 or Windows 10, use the command `net user administrator /active:yes` to activate the native Administrator account. If Administrator remains disabled, you might need the intervention of your IT department or network admin.

Windows Server 2012 SafeNet HSM Client Supplemental Configuration

If you are installing the SafeNet HSM client on Windows Server 2012, some additional configuration is required to install the .NET framework that is required for the HTL Client Service.

If your Windows Server 2012 instance is not properly configured with .NET Framework, the following alert message appears during the SafeNet Client installation:

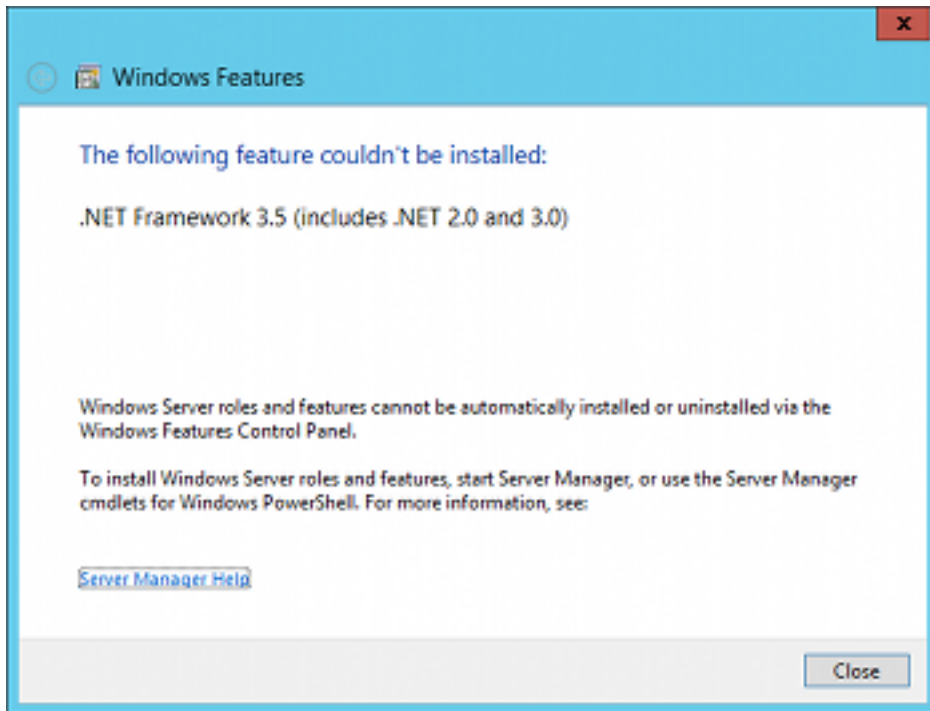

When you close the alert, a message about the HTL Client service appears.

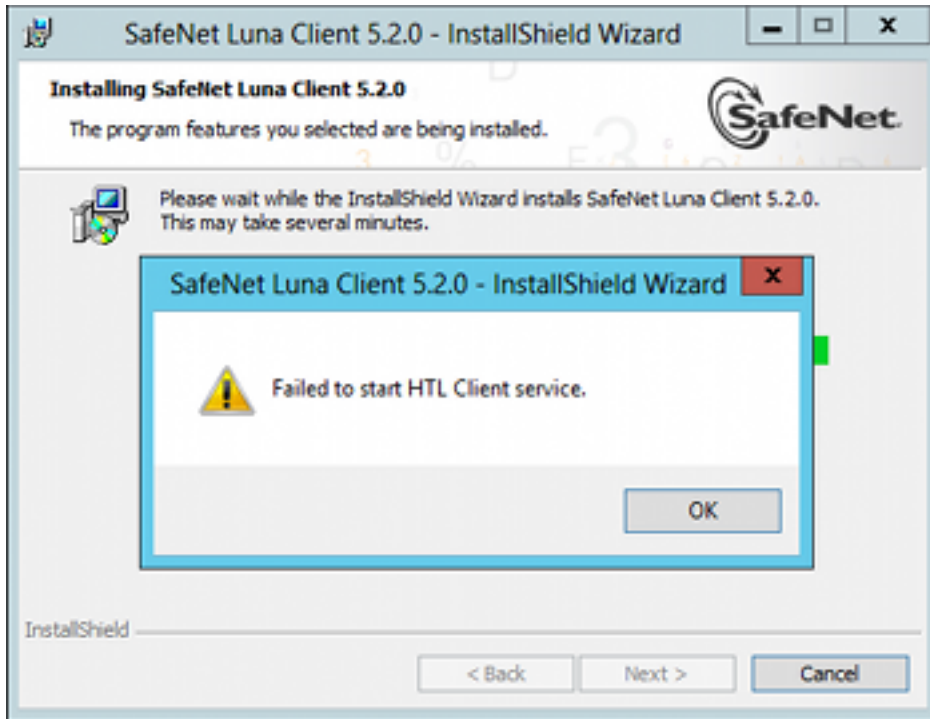

To avoid this issue, install Microsoft .NET Framework 3.5 on your Windows Server 2012 instance before you run the SafeNet Client 6.x installer.

Installing the .NET Framework 3.5 on Windows Server 2012

The .NET Framework 3.5 is required by the HTL Client service.

To install the .NET Framework 3.5 on Windows Server 2012

1. On your Windows Server 2012, launch **Server Manager**.
2. In Server Manager, click the **Manage** button and select **Add Roles and Features**.

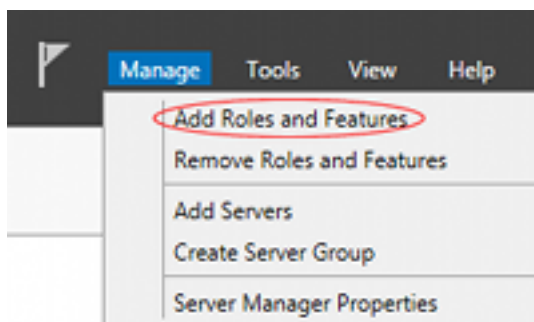

3. Configure the Add Roles and Features Wizard as follows:
 - a. Select **Role-based or feature-based** as the Installation type.
 - b. Select your server.
 - c. Check the **Application Server** role.
 - d. Click **Next**.

Before You Begin
Installation Type
Server Selection
Server Roles
Features
Application Server
 Role Services
Confirmation
Results

Select one or more features to install on the selected server.
NET Framework 3.5 Features must be checked in order for the HTL Client Service to install correctly. Leaving just the existing 4.5 Features will not resolve the issue.

Features	Description
<input type="checkbox"/> .NET Framework 3.5 Features	.NET Framework 3.5 combines the power of the .NET Framework 2.0 APIs with new technologies for building applications that offer appealing user interfaces, protect your customers' personal identity information, enable seamless and secure communication, and provide the ability to model a range of business processes.
<input checked="" type="checkbox"/> .NET Framework 4.5 Features (Installed)	
<input type="checkbox"/> Background Intelligent Transfer Service (BITS)	
<input type="checkbox"/> BitLocker Drive Encryption	
<input type="checkbox"/> BitLocker Network Unlock	
<input type="checkbox"/> BranchCache	
<input type="checkbox"/> Client for NFS	
<input type="checkbox"/> Data Center Bridging	
<input type="checkbox"/> Enhanced Storage	
<input type="checkbox"/> Failover Clustering	
<input type="checkbox"/> Group Policy Management	
<input type="checkbox"/> Ink and Handwriting Services	
<input type="checkbox"/> Internet Printing Client	
<input type="checkbox"/> IP Address Management (IPAM) Server	
<input type="checkbox"/> iSNS Server service	
<input type="checkbox"/> LPR Port Monitor	
<input type="checkbox"/> Management OData IIS Extension	

< Previous Next > Install Cancel

3:04 PM
9/24/2014

Add Roles and Features Wizard

Before you begin

DESTINATION SERVER
WIN-18A0203H4

Before You Begin
Installation Type
Server Selection
Server Roles
Features
Confirmation
Results

This wizard helps you install roles, role services, or features. You determine which roles, role services, or features to install based on the computing needs of your organization, such as sharing documents, or hosting a website.

To remove roles, role services, or features:
Start the [Remove Roles and Features Wizard](#)

Before you continue, verify that the following tasks have been completed:

- The Administrator account has a strong password
- Network settings, such as static IP addresses, are configured
- The most current security updates from Windows Update are installed

If you must verify that any of the preceding prerequisites have been completed, close the wizard, complete the steps, and then run the wizard again.

To continue, click Next.

Skip this page by default

< Previous Next > Install Cancel

4. Click through the remaining screens to confirm your installation source and then click **Install**.

After the installation has completed, you will be able to install the SafeNet Client on Windows Server 2012.

Scripted / Unattended Installation on Windows

The Windows software installation section describes interactive installation on Windows systems, using the graphical, interactive installer. This section describes how to perform unattended or scripted installations on Windows platforms.

Installing the SafeNet Client For All SafeNet Products

From the location of **LunaClient.msi**, run the following command:

```
LunaClient.exe /I lunaclient_wininstall.log /quiet addlocal=all /qn
```

The setting **/I lunaclient_wininstall.log** is optional and will place the installation logs into the file **lunaclient_wininstall.log**.

Windows security popup on each SafeNet product driver install

The windows security notice (below) appears because “SafeNet, Inc.” is not among the trusted publishers on your computer:

- If you check the **Always trust software from...** checkbox and then click on the **Install** button the dialog will not appear on future installations, on that computer.
- If you do not check the **Always trust software from...** checkbox then you might see the dialog three times, once for each of the three SafeNet products (SafeNet PCIe HSM, SafeNet USB HSM and SafeNet Remote Backup HSM) that install a driver on your computer.



This is a Windows security requirement, introduced with Windows 2008, and is not under our control. Installing marks the publisher (in this case, SafeNet, Inc.) as trusted for future installations.

Installing the SafeNet Client For SafeNet Network HSM

From the location of **LunaClient.exe** run the following commands:

1. Install default SafeNet Client components for SafeNet Network HSM

```
LunaClient.exe /I lunaclient_wininstall.log /quiet addlocal=SA /qn
```

2. Install all SafeNet Client components for SafeNet Network HSM

```
LunaClient.exe /I lunaclient_wininstall.log /quiet addlocal=SA, SA_CSP_KSP, SA_JSP, SA_SDK, SA_JCProv, SA_LDPC /qn
```

Product or component	Description
SA_CSP_KSP	Install SafeNet CSP and KSP components
SA_JSP	Install SafeNet JSP component
SA_SDK	Install SafeNet SDK component
SA_JCProv	Install SafeNet JCPROV component



Note: If you wish to install only some of the components, just specify the ones you want after the product name (SA in this example).



Note: The Windows security warning mentioned in section 1 (above) does not appear when only SafeNet Network HSM is installed, because no driver is require. It appears only if you also install SafeNet PCIe HSM, or SafeNet USB HSM, or SafeNet Backup HSM on the client computer.

Installing the Luna Client for SafeNet PCIe HSM

From the location of **LunaClient.exe** run the following commands:

1. Install default Luna Client components for SafeNet PCIe HSM

LunaClient.exe /l lunaclient_winstall.log /quiet addlocal=PCI /qn

2. Install all Luna Client components for SafeNet PCIe HSM

LunaClient.exe /l lunaclient_winstall.log /quiet addlocal=PCI, PCI_CSP_KSP, PCI_JSP, PCI_SDK, PCI_JCProv, PCI_SNMP /qn

Product or component	Description
PCI_CSP_KSP	Install Luna CSP and KSP components
PCI_JSP	Install Luna JSP component
PCI_SDK	Install Luna SDK component
PCI_JCProv	Install Luna JCPROV component
PCI_SNMP	Install Luna SNMP subagent component



Note: The Windows security warning mentioned in section 1 (above) also appears when you install SafeNet PCIe HSM, unless you have already accepted a driver installation, and therefore recognized SafeNet, Inc. as a trusted publisher.

Installing the Luna Client For SafeNet USB HSM

From the location of **LunaClient.exe** run the following command:

1. Install default Luna Client components for SafeNet USB HSM

LunaClient.exe /l lunaclient_wininstall.log /quiet addlocal=G5 /qn

2. Install all Luna Client components for SafeNet USB HSM

LunaClient.exe /l lunaclient_wininstall.log /quiet addlocal=G5, G5_CSP_KSP, G5_JSP, G5_SDK, G5_JCProv, G5_SNMP /qn

Product or component	Description
G5_CSP_KSP	Install Luna CSP and KSP components
G5_JSP	Install Luna JSP component
G5_SDK	Install Luna SDK component
G5_JCProv	Install Luna JC PROV component
G5_SNMP	Install Luna SNMP subagent component



Note: The Windows security warning mentioned in section 1 (above) also appears when you install SafeNet USB HSM, unless you have already accepted a driver installation, and therefore recognized SafeNet, Inc. as a trusted publisher.

Installing the Luna Client for SafeNet Remote Backup HSM

From the location of **LunaClient.exe** run the following command:

LunaClient.exe /l lunaclient_wininstall.log /quiet addlocal=RB, RB_SNMP /qn

Product or component	Description
RB_SNMP	Install Luna SNMP subagent component



Note: The Windows security mentioned in section 1 (above) also appears when you install SafeNet Remote Backup HSM, unless you have already accepted a driver installation, and therefore recognized SafeNet, Inc. as a trusted publisher.

Installing the Luna Client for Remote PED

From the location of **LunaClient.exe** run the following command:

LunaClient.exe /l lunaclient_wininstall.log /quiet addlocal=RP /qn



Note: When **msiexec.exe** is used to install Luna Client there is no message confirming that the installation has completed. The **msiexec.exe** utility just returns to the command line when the installation finishes.